

ELBI
ELECTRIC
turn on the life



2023-2024
ZENA VEGA JAZZ

CATALOG / KATALOG
EN-TUR

CONTENTS / İÇİNDEKİLER

Zena	03
Vega	11
Jazz	19
Teknik Bilgiler	27
Ambalaj Bilgileri	33

zena



ELBI
ELECTRIC

Montage Schema / Montaj Şeması



Frame Size / Çerçeve Ebatları

Single Frame / Tekli Çerçeve
608-01XX00-271

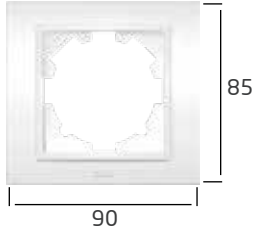

6 Gang Frame / Altılı Çerçeve
500-01XX00-252

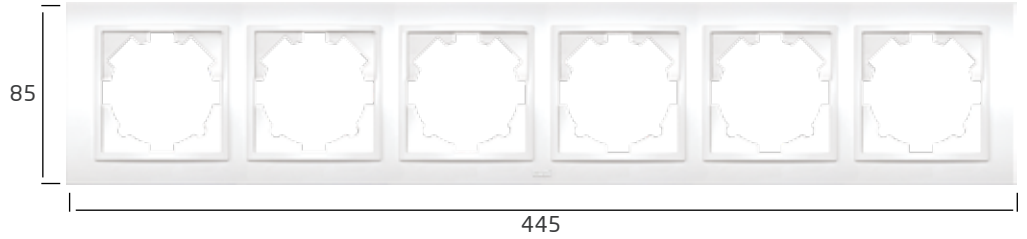

2 Gang Frame / İkilili Çerçeve
500-01XX00-226



5 Gang Frame / Beşli Çerçeve
500-01XX00-250



3 Gang Frame / Üçlü Çerçeve
500-01XX00-227



4 Gang Frame / Dörtlü Çerçeve
500-01XX00-228

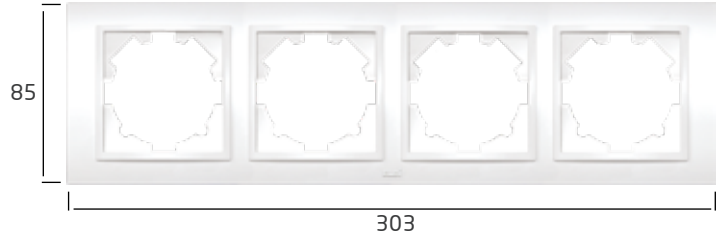

Quick Connect / Hızlı Bağlantı

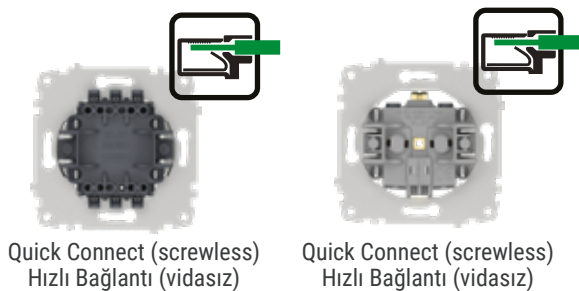

* To select color of product please replace the XX with the color code: White 02, Cream 03, Black 30, Snow White 56, Latte (Anthracite) 40, M. Grey 10, Fume 11, Titanium 14, Ivory 25, Vantablack 48, Maple 27, New Cherry 28, White Oak 42, Mahogany 29, Matt White 62, Matt Cream 65, Mat Fume 67.

* Ürün renklerini belirtmek için ürün kodundaki XX yerine; 02 Beyaz, 03 Krem, 30 Siyah, 56 Karbeyaz, 40 Latte (Antrasit), 10 M. Gri, 11 Füme, 14 Titanyum, 25 Fildişi, 48 Vantablack, 28 Yeni Kiraz, 42 Beyaz Meşe, 29 Maun, 27 Akçaağaç, 62 Mat Beyaz, 65 Mat Krem, 67 Mat Füme gelecek şekilde sipariş verilmelidir.

zena

Color Options / Renk Seçenekleri

zenanatural



WHITE
BEYAZ

500-010200-200



CREAM
KREM

500-010300-200



BLACK
SIYAH

500-013000-200



SNOWWHITE
KARBELAZ

500-015600-200

zenasilverline



METALLIC GREY
METALİK GRİ

500-011000-200



FUME
FÜME

500-011100-200



TITANIUM
TİTANYUM

500-011400-200



LATTE (ANTHRACITE)
LATTE (ANTRASİT)

500-014000-200



IVORY
FİL DİŞİ

500-012500-200



VANTABLACK

500-014800-200

zenawoodline



MAPLE
AKÇAĞAÇ

500-012700-200



NEW CHERRY
YENİ KIRAZ

500-012800-200



MAHOGANY
MAUN

500-012900-200



WHITE OAK
BEYAZ MEŞE

500-014200-200

zenapastel



MATT WHITE
MAT BEYAZ

500-016200-200



MATT CREAM
MAT KREM

500-016500-200

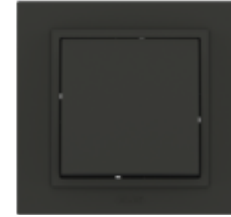

MATT FUME
MAT FÜME

500-016700-200

* To select color of product please replace the XX with the color code: White 02, Cream 03, Black 30, Snow White 56, Latte (Anthracite) 40, M. Grey 10, Fume 11, Titanium 14, Ivory 25, Vantablack 48, Maple 27, New Cherry 28, White Oak 42, Mahogany 29, Matt White 62, Matt Cream 65, Mat Fume 67.

* Ürün renklerini belirtmek için ürün kodundaki XX yerine; 02 Beyaz, 03 Krem, 30 Siyah, 56 Karbeyaz, 40 Latte (Antrasit), 10 M. Gri, 11 Füme, 14 Titanyum, 25 Fildişi, 48 Vantablack, 28 Yeni Kiraz, 42 Beyaz Meşe, 29 Maun, 27 Akçağaç, 62 Mat Beyaz, 65 Mat Krem, 67 Mat Füme gelecek şekilde sipariş verilmelidir.

Functions / Fonksiyonlar



1Gang 1Way Switch
Anahtar

500-01XX00-200



1Gang 1Way
Switch Illuminated
Işıklı Anahtar

500-01XX00-201



2Gang 1Way Switch
Komütatör

500-01XX00-202



2Gang 1Way
Switch Illuminated
Işıklı Komütatör

500-01XX00-203



Control Switch Door
Kapı Otomatığı

500-01XX00-204



Control Switch Light
Light Anahtarı

500-01XX00-205



Control Switch
Illuminated Light
Işıklı Light Anahtar

500-01XX00-206



Control Switch Bell
Zil Anahtarı

500-01XX00-207



12V Illuminated Labelled
Control Switch Bell
12V Işıklı İsimli Zil

500-01XX00-208



1Gang 2Way Switch
Vavien

500-01XX00-209



1 Gang 2 Way
Switch Illuminated
Işıklı Vavien

500-01XX00-210



2 Gang 2 Way Switch
Komütatör Vavien

500-01XX00-211



1 Gang 2 Way
Switch Intermediate
Ara Vavien (Permütatör)

500-01XX00-214



Blind Switch
Jaluzi Kumanda Anahtarı

500-01XX00-216



Double Pole
Switch Illuminated
İki Kutuplu Işıklı Anahtar

500-01XX00-236



3 Gang 1 Way Switch
Üçlü Anahtar

500-01XX00-254

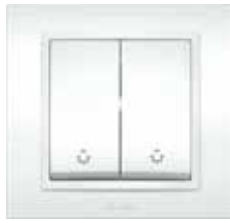

2 Gang 1 Way
Control Switch Light
Komütatör Light

500-01XX00-257

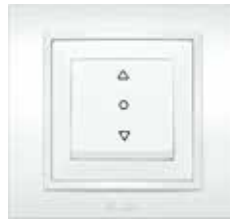

Blind Control Switch
(3 Position) Tek Düğmeli
Jaluzi Anahtarı (3 Konumlu)

500-01XX00-297



Double Pole Switch
İki Kutuplu Anahtar

500-01XX00-269



Vavien + Light Switch
Vavien + Light Anahtar

500-01XX00-281

■ Hızlı bağlantı seçimi için lütfen 01 yerine 03 yazınız. / For quick connection selection, please write 01 instead of 03.

* To select color of product please replace the XX with the color code: White 02, Cream 03, Black 30, Snow White 56, Latte (Anthracite) 40, M. Grey 10, Fume 11, Titanium 14, Ivory 25, Vantablack 48, Maple 27, New Cherry 28, White Oak 42, Mahogany 29, Matt White 62, Matt Cream 65, Mat Fume 67.

* Ürün renklerini belirtmek için ürün kodundaki XX yerine; 02 Beyaz, 03 Krem, 30 Siyah, 56 Karbeyaz, 40 Latte (Antrasit), 10 M. Gri, 11 Füme, 14 Titanyum, 25 Fildişi, 48 Vantablack, 28 Yeni Kiraz, 42 Beyaz Meşe, 29 Maun, 27 Akçaağaç, 62 Mat Beyaz, 65 Mat Krem, 67 Mat Füme gelecek şekilde sipariş verilmelidir.

Functions / Fonksiyonlar



3Gang 1Way Hvac Switch
3'lü Klima Anahtarı

500-01XX00-279



Socket Outlet Without Earthed Priz

500-01XX00-215

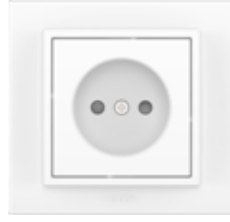

Child Protection Socket Without Earthed
Çocuk Korumalı Priz

500-01XX00-286



Socket Outlet Earthed
Topraklı Priz

500-01XX00-217



Socket Outlet Earthed With Hinged Lid
Kapaklı Topraklı Priz

500-01XX00-218



Socket Outlet Earthed Child Protection With Hinged Lid
Çocuk Korumalı Kapaklı Topraklı Priz

500-01XX00-219



Socket Outlet Earthed Child Protection
Çocuk Korumalı Topraklı Priz

500-01XX00-243



Child Protection Ups Socket Outlet Earthed Pin
Çocuk Korumalı UPS priz

500-01XX00-263



Ups Socket Outlet With Earthed Pin
UPS Priz

500-01XX00-268



Double USB Socket Outlet Earthed Child protection
İkili USB Topraklı Priz Çocuk Korumalı

500-01XX00-317



SAT Socket Outlet F Type
(RG 6 F Connector)
Uydu Prizi (F dişi Konnektörlü)
(RG 6 F Connector)

500-01XX00-180



TV Socket Outlet Through Line
TV Priz - Geçişli

500-01XX00-224



TV Socket Outlet End Of Line
TV Priz - Sonlu

500-01XX00-246



SAT Socket Outlet F Type Through Line (F Konnektörlü)
Uydu Prizi Geçişli (F konnektörlü)

500-01XX00-287



SAT Socket Outlet F Type End Of Line Uydu Prizi Sonlu (F konnektörlü)

500-01XX00-288



TV + SAT Socket Outlet Through Line
TV + SAT Prizi - Geçişli

500-01XX00-289



Tv + SAT Socket Outlet End Of Line
TV + SAT Prizi - Sonlu

500-01XX00-290



Shielded Tv Socket Outlet Without Resistance
TV Prizi Ekranlı - Dirençsiz

500-01XX00-274



Cable Outlet Cover
Kablo Çıkış Kapağı

500-01XX00-298



Shielded Tv Socket Outlet Through Line
TV Prizi Ekranlı-Geçişli

500-01XX00-272

Hızlı bağlantı seçimi için lütfen **01** yerine **03** yazınız. / For quick connection selection, please write **01** instead of **03**.

* To select color of product please replace the **XX** with the color code: White **02**, Cream **03**, Black **30**, Snow White **56**, Latte (Anthracite) **40**, M. Grey **10**, Fume **11**, Titanium **14**, Ivory **25**, Vantablack **48**, Maple **27**, New Cherry **28**, White Oak **42**, Mahogany **29**, Matt White **62**, Matt Cream **65**, Mat Fume **67**.

* Ürün renklerini belirtmek için ürün kodundaki **XX** yerine; **02** Beyaz, **03** Krem, **30** Siyah, **56** Karbeyaz, **40** Latte (Antrasit), **10** M. Gri, **11** Füme, **14** Titanyum, **25** Fildişi, **48** Vantablack, **28** Yeni Kiraz, **42** Beyaz Meşe, **29** Maun, **27** Akçaağaç, **62** Mat Beyaz, **65** Mat Krem, **67** Mat Füme gelecek şekilde sipariş verilmelidir.

Functions / Fonksiyonlar



**Shielded Tv Socket Outlet
End Of Line**
TV Prizi Ekranlı-Sonlu

500-01XX00-273



SAT Socket Outlet F Type
Uydu Prizi
(F dişi Konnektörü)

500-01XX00-280



**Tv + Rad + SAT Socket
Outlet Through Line**
TV + Radyo + SAT - Geçişli

500-01XX00-233



**Tv + Rad + SAT Socket
Outlet End Of Line**
TV + Radyo + SAT - Sonlu

500-01XX00-234



VGA Socket
VGA Priz

500-01XX00-173



**Numeris Telephone
Socket Outlet** (RJ11 CAT3)
Nümeris Prizi (RJ11 CAT3)

500-01XX00-221



**Double Numeris Telephone
Socket Outlet** (2 x RJ11 CAT3) /
İkili Nümeris Prizi (2 x RJ11 CAT3)

500-01XX00-222



Data Socket Outlet
(RJ45 Cat6)
Data Prizi (RJ45 CAT6)

500-01XX00-247



**Double Data Socket
Outlet** (2 x RJ45 CAT6)
İkili Data Prizi (2 x RJ45 CAT6)

500-01XX00-248



USB Connector (Data Transfer)
USB Konnektör (Veri Transferi)

500-01XX00-242



**Data + Numeris Telephone Socket
Outlet** (RJ45 CAT6 + RJ11 CAT3)
Data Prizi+Nümeris Priz
(RJ45 CAT6 + RJ11 CAT3)

500-01XX00-249



**Data + Numeris Telephone
Socket Outlet Without Jack**
Data prizi + Nümeris Priz Jaksız

500-01XX00-260



**Numeris Socket
Without Jack**
Nümeris Prizi Jaksız

500-01XX00-282



Data Socket Without Jack
Data Prizi Jaksız

500-01XX00-296



**Music Hi-Fi Socket
Outlet 2 Gang**
İkili Müzik Yayın Prizi

500-01XX00-241



Fiber Optic Data Socket
Fiber Optik Data Prizi

500-01XX00-300



**Double Fiber Optic
Data Socket**
İkili Fiber Optik Data Prizi

500-01XX00-304



Double USB Charger 5V 2,1A
USB Şarj Prizi 5V 2,1A Çiftli

500-01XX00-143



HDMI Socket
HDMI Priz

500-01XX00-284

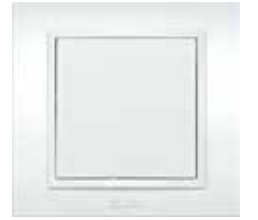

Blind Cover
Kör Kapak

500-01XX00-299

* To select color of product please replace the XX with the color code: White 02, Cream 03, Black 30, Snow White 56, Latte (Anthracite) 40, M. Grey 10, Fume 11, Titanium 14, Ivory 25, Vantablack 48, Maple 27, New Cherry 28, White Oak 42, Mahogany 29, Matt White 62, Matt Cream 65, Mat Fume 67.

* Ürün renklerini belirtmek için ürün kodundaki XX yerine; 02 Beyaz, 03 Krem, 30 Siyah, 56 Karbeyaz, 40 Latte (Antrasit), 10 M. Gri, 11 Füme, 14 Titanyum, 25 Fildişi, 48 Vantablack, 28 Yeni Kiraz, 42 Beyaz Meşe, 29 Maun , 27 Akçaağaç, 62 Mat Beyaz, 65 Mat Krem, 67 Mat Füme gelecek şekilde sipariş verilmelidir.

Functions / Fonksiyonlar



**Double USB(Type C+A) Socket
Outlet Earthed Child protection**
İkili USB(Type C+A) Topraklı Priz
Çocuk Korumalı

500-01XX00-334



**Double USB Charging
Socket (Type C+A)**
USB Şarj Prizi (Type C+A) Çiftli

500-01XX00-335



Relay Motion Sensor
Röleli Hareket Sensörü

500-01XX00-262



Triac Motion Sensor
Triyaklı Hareket Sensörü

500-01XX00-264



Dimmer 500W CE
Dimmer 500W CE

500-01XX00-144



Dimmer Illuminated (1000W)
Işıklı Dimmer (1000W)

500-01XX00-192



Music Volume Control Switch
Müzik Yayın Anahtarı

500-01XX00-261



Dimmer (1000W)
Dimmer (1000W)

500-01XX00-112



**110V Ventilator Control
Switch 200W**
110V Fan Dimmer 200W

500-01XX00-277



**220V Ventilator Control
Switch 200W**
220V Fan Dimmer 200W

500-01XX00-278



RC Led dimmer 5-60W
RC Led dimmer 5-60W

500-01XX00-308



1-10V Dimmer
1-10V Dimmer

500-01XX00-316



5-300W RC Dimmer
5-300W RC Dimmer

500-01XX00-310



Optic Energy Saver Delayed
Optik Algılamalı Enerji
Saver Gecikmeli

500-01XX00-291



Rfid Energy Saver
Rfid Enerji Saver

500-01XX00-158



Rf Energy Saver
Rf Enerji Saver

500-01XX00-318



Universal Energy Saver
Üniversal Enerji Saver

500-01XX00-265



Mechanical Energy Saver
Mekanik Enerji Saver

500-01XX00-266



**Double USB Charging
HDMI Socket**

İkili USB Şarj HDMI Prizi

500-01XX00-337

* To select color of product please replace the XX with the color code: White 02, Cream 03, Black 30, Snow White 56, Latte (Anthracite) 40, M. Grey 10, Fume 11, Titanium 14, Ivory 25, Vantablack 48, Maple 27, New Cherry 28, White Oak 42, Mahogany 29, Matt White 62, Matt Cream 65, Mat Fume 67.

* Ürün renklerini belirtmek için ürün kodundaki XX yerine; 02 Beyaz, 03 Krem, 30 Siyah, 56 Karbeyaz, 40 Latte (Antrasit), 10 M. Gri, 11 Füme, 14 Titanyum, 25 Fildişi, 48 Vantablack, 28 Yeni Kiraz, 42 Beyaz Meşe, 29 Maun, 27 Akçaağaç, 62 Mat Beyaz, 65 Mat Krem, 67 Mat Füme gelecek şekilde sipariş verilmelidir.

Gang Frames / Çoklu Çerçeveler



Single Frame / Tekli Çerçeve
608-01XX00-271

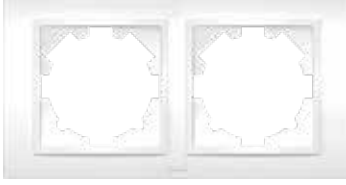

2 Gang Frame / İkilü Çerçeve
500-01XX00-226



3 Gang Frame / Üçlü Çerçeve
500-01XX00-227

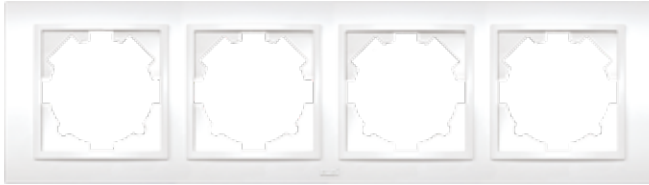

4 Gang Frame / Dörtlü Çerçeve
500-01XX00-228



5 Gang Frame / Beşli Çerçeve
500-01XX00-250



6 Gang Frame / Altılı Çerçeve
500-01XX00-252



Double Socket Outlet Without Earthed
İkilü Sıva Altı Priz

500-01XX00-908



Double Socket Outlet Earthed
İkilü Sıva Altı Topraklı Priz

500-01XX00-907



Flush Mounted 3G Earthed Socket Outlet
Sıvaaltı Üçlü Topraklı Priz

500-00XX00-819

*only natural and silverline series.

*sadece natural ve silverline serilerimizde vardır.



Surface Mounting Box
Sıva Üstü Kasa

500-01XX00-253

◆ Multiple frames can be used horizontally and vertically. / Çoklu çerçeveler yatay ve dikey olarak kullanılabilir.

* To select color of product please replace the XX with the color code: White 02, Cream 03, Black 30, Snow White 56, Latte (Anthracite) 40, M. Grey 10, Fume 11, Titanium 14, Ivory 25, Vantablack 48, Maple 27, New Cherry 28, White Oak 42, Mahogany 29, Matt White 62, Matt Cream 65, Mat Fume 67.

* Ürün renklerini belirtmek için ürün kodundaki XX yerine; 02 Beyaz, 03 Krem, 30 Siyah, 56 Karbeyaz, 40 Latte (Antrasit), 10 M. Gri, 11 Füme, 14 Titanyum, 25 Fildişi, 48 Vantablack, 28 Yeni Kiraz, 42 Beyaz Meşe, 29 Maun, 27 Akçaağaç, 62 Mat Beyaz, 65 Mat Krem, 67 Mat Füme gelecek şekilde sipariş verilmelidir.

vega



Montage Schema / Montaj Şeması

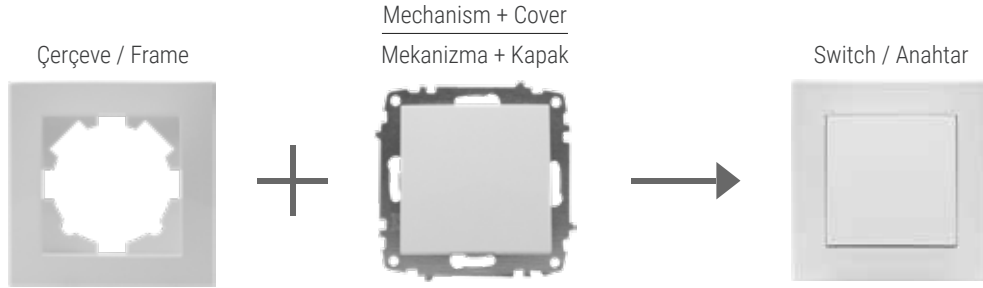

Frame Size / Çerçeve Ebatları

Single Frame / Tekli Çerçeve
510-01XX00-271

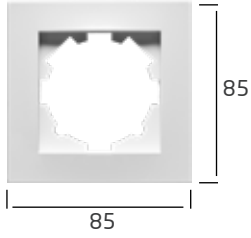

6 Gang Frame / Altılı Çerçeve
510-01XX00-252

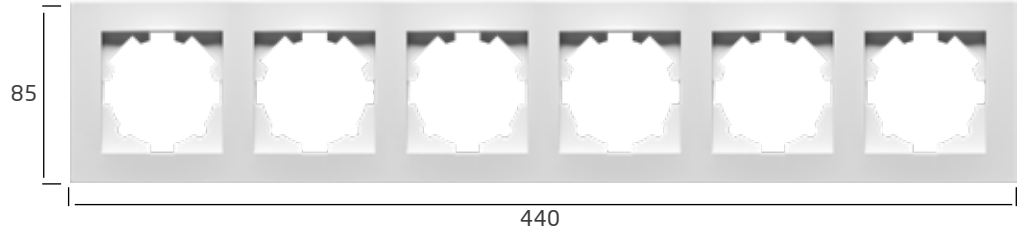

2 Gang Frame / İkilili Çerçeve
510-01XX00-226

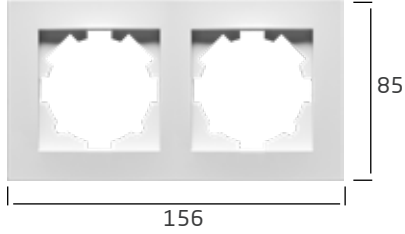

5 Gang Frame / Beşli Çerçeve
510-01XX00-250

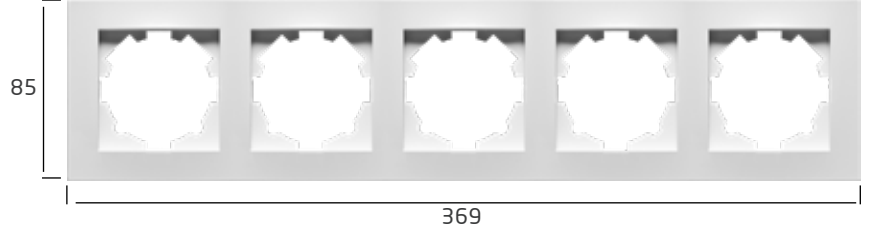

3 Gang Frame / Üçlü Çerçeve
510-01XX00-227

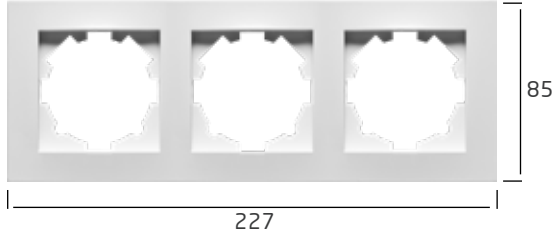

4 Gang Frame / Dörtlü Çerçeve
510-01XX00-228

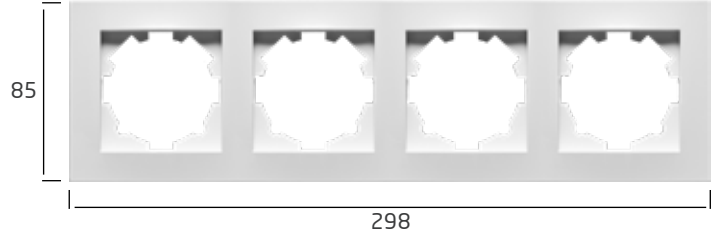

Quick Connect / Hızlı Bağlantı

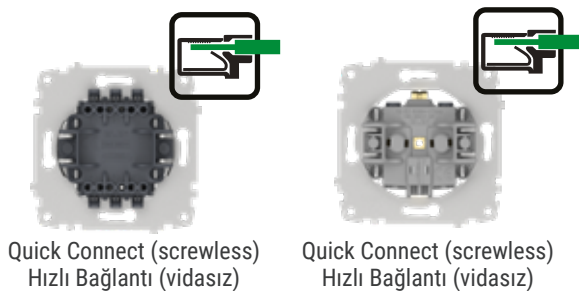

* To select color of product please replace the XX with the color code: White 02, Cream 03, Black 30, Snow White 56, Latte (Anthracite) 40, M. Grey 10, Fume 11, Titanium 14, Ivory 25, Vantablack 48, Maple 27, New Cherry 28, White Oak 42, Mahogany 29, Matt White 62, Matt Cream 65, Mat Fume 67.

* Ürün renklerini belirtmek için ürün kodundaki XX yerine; 02 Beyaz, 03 Krem, 30 Siyah, 56 Karbeyaz, 40 Latte (Antrasit), 10 M. Gri, 11 Füme, 14 Titanyum, 25 Fildişi, 48 Vantablack, 28 Yeni Kiraz, 42 Beyaz Meşe, 29 Maun, 27 Akçaağaç, 62 Mat Beyaz, 65 Mat Krem, 67 Mat Füme gelecek şekilde sipariş verilmelidir.

Color Options / Renk Seçenekleri

veganatural

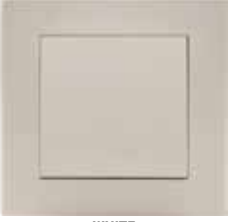

WHITE
BEYAZ

510-010200-200

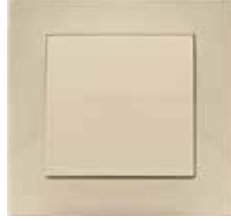

CREAM
KREM

510-010300-200



BLACK
SİYAH

510-013000-200



SNOWWHITE
KARBELAZ

510-015600-200

vegasilverline



METALLIC GREY
METALİK GRİ

510-011000-200



FUME
FÜME

510-011100-200



TITANIUM
TİTANYUM

510-011400-200



LATTE (ANTHRACITE)
LATTE (ANTRASİT)

510-014000-200

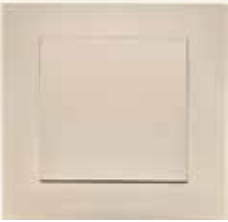

IVORY
FİL DİŞİ

510-012500-200



VANTABLACK

510-014800-200

vegawoodline



MAPLE
AKÇAĞAÇ

510-012700-200



NEW CHERRY
YENİ KIRAZ

510-012800-200



MAHOGANY
MAUN

510-012900-200



WHITE OAK
BEYAZ MEŞE

510-014200-200

vegapastel



MATT WHITE
MAT BEYAZ

510-016200-200



MATT CREAM
MAT KREM

510-016500-200

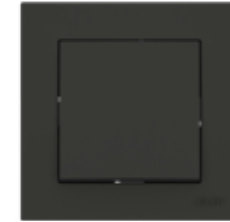

MATT FUME
MAT FÜME

510-016700-200

* To select color of product please replace the XX with the color code: White 02, Cream 03, Black 30, Snow White 56, Latte (Anthracite) 40, M. Grey 10, Fume 11, Titanium 14, Ivory 25, Vantablack 48, Maple 27, New Cherry 28, White Oak 42, Mahogany 29, Matt White 62, Matt Cream 65, Mat Fume 67.

* Ürün renklerini belirtmek için ürün kodundaki XX yerine; 02 Beyaz, 03 Krem, 30 Siyah, 56 Karbeyaz, 40 Latte (Antrasit), 10 M. Gri, 11 Füme, 14 Titanyum, 25 Fildişi, 48 Vantablack, 28 Yeni Kiraz, 42 Beyaz Meşe, 29 Maun, 27 Akçaağaç, 62 Mat Beyaz, 65 Mat Krem, 67 Mat Füme gelecek şekilde sipariş verilmelidir.

Functions / Fonksiyonlar



1Gang 1Way Switch
Anahtar

510-01XX00-200



1Gang 1Way Switch
Illuminated
Işıklı Anahtar

510-01XX00-201



2Gang 1Way Switch
Komütatör

510-01XX00-202



2Gang 1Way Switch
Illuminated
Işıklı Komütatör

510-01XX00-203



Control Switch Door
Kapı Otomatiği

510-01XX00-204



Control Switch Light
Light Anahtarı

510-01XX00-205



Control Switch
Illuminated Light
Işıklı Light Anahtar

510-01XX00-206



Control Switch Bell
Zil Anahtarı

510-01XX00-207



12V Illuminated Labeled
Control Switch Bell
12V Işıklı İsimli Zil

510-01XX00-208



1Gang 2Way Switch
Vavien

510-01XX00-209



1 Gang 2 Way
Switch Illuminated
Işıklı Vavien

510-01XX00-210



2 Gang 2 Way Switch
Komütatör Vavien

510-01XX00-211



1 Gang 2 Way
Switch Intermediate
Ara Vavien (Permütatör)

510-01XX00-214



Blind Switch
Jaluzi Kumanda Anahtarı

510-01XX00-216



Double Pole Switch
Illuminated
İki Kutuplu Işıklı Anahtar

510-01XX00-236



3 Gang 1 Way Switch
Üçlü Anahtar

510-01XX00-254



2 Gang 1 Way
Control Switch Light
Komütatör Light

510-01XX00-257



Blind Control Switch
(3 Position)
Tek Düğmeli Jaluzi
Anahtarı (3 Konumlu)

510-01XX00-297



Double Pole Switch
İki Kutuplu Anahtar

510-01XX00-269



Vavien + Light Switch
Vavien + Light Anahtar

510-01XX00-281

Hızlı bağlantı seçimi için lütfen **01** yerine **03** yazınız. / For quick connection selection, please write **01** instead of **03**.

* To select color of product please replace the **XX** with the color code: White **02**, Cream **03**, Black **30**, Snow White **56**, Latte (Anthracite) **40**, M. Grey **10**, Fume **11**, Titanium **14**, Ivory **25**, Vantablack **48**, Maple **27**, New Cherry **28**, White Oak **42**, Mahogany **29**, Matt White **62**, Matt Cream **65**, Mat Fume **67**.

* Ürün renklerini belirtmek için ürün kodundaki **XX** yerine; **02** Beyaz, **03** Krem, **30** Siyah, **56** Karbeyaz, **40** Latte (Antrasit), **10** M. Gri, **11** Füme, **14** Titanyum, **25** Fildişi, **48** Vantablack, **28** Yeni Kiraz, **42** Beyaz Meşe, **29** Maun, **27** Akçaağaç, **62** Mat Beyaz, **65** Mat Krem, **67** Mat Füme gelecek şekilde sipariş verilmelidir.

Functions / Fonksiyonlar



3Gang 1Way Hvac Switch
3'lü Klima Anahtarı

510-01XX00-279

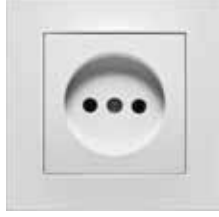

Socket Outlet Without Earthed Priz

510-01XX00-215



Child Protection Socket Outlet Without Earthed Çocuk Korumalı Priz

510-01XX00-286



Socket Outlet Earthed Topraklı Priz

510-01XX00-217



Socket Outlet Earthed With Hinged Lid Kapaklı Topraklı Priz

510-01XX00-218



Socket Outlet Earthed Child Protection With Hinged Lid Çocuk Korumalı Kapaklı Topraklı Priz

510-01XX00-219



Socket Outlet Earthed ChildProtection Çocuk Korumalı Topraklı Priz

510-01XX00-243



Child Protection Ups Socket Outlet Earthed Pin Çocuk Korumalı UPS Priz

510-01XX00-263



Ups Socket Outlet With Earthed Pin UPS Priz

510-01XX00-268



Double USB Socket Outlet Earthed Child protection İkili USB Topraklı Priz Çocuk Korumalı

510-01XX00-317



SAT Socket Outlet F Type (RG 6 F Connector) Uydu Prizi (RG 6 F Connector)

510-01XX00-180



TV Socket Outlet Through Line TV Priz - Geçişli

510-01XX00-224



TV Socket Outlet End Of Line TV Priz - Sonlu

510-01XX00-246



SAT Socket Outlet F Type Through Line Uydu prizi geçişli (F dişi Konnektörlü)

510-01XX00-287



SAT Socket Outlet F Type End Of Line Uydu prizi sonlu (F dişi Konnektörlü)

510-01XX00-288



Tv + SAT Socket Outlet Through Line TV + SAT Prizi - Geçişli

510-01XX00-289



Tv + SAT Socket Outlet End Of Line TV + SAT Prizi - Sonlu

510-01XX00-290



Shielded Tv Socket Outlet Without Resistance TV Prizi Ekranlı - Dirençsiz

510-01XX00-274



Cable Outlet Cover Kablo Çıkış Kapağı

510-01XX00-298



Shielded Tv Socket Outlet Through Line TV Prizi Ekranlı-Geçişli

510-01XX00-272

Hızlı bağlantı seçimi için lütfen **01** yerine **03** yazınız. / For quick connection selection, please write **01** instead of **03**.

* To select color of product please replace the **XX** with the color code: White **02**, Cream **03**, Black **30**, Snow White **56**, Latte (Anthracite) **40**, M. Grey **10**, Fume **11**, Titanium **14**, Ivory **25**, Vantablack **48**, Maple **27**, New Cherry **28**, White Oak **42**, Mahogany **29**, Matt White **62**, Matt Cream **65**, Mat Fume **67**.

* Ürün renklerini belirtmek için ürün kodundaki **XX** yerine; **02** Beyaz, **03** Krem, **30** Siyah, **56** Karbeyaz, **40** Latte (Antrasit), **10** M. Gri, **11** Füme, **14** Titanyum, **25** Fildişi, **48** Vantablack, **28** Yeni Kiraz, **42** Beyaz Meşe, **29** Maun, **27** Akçaağaç, **62** Mat Beyaz, **65** Mat Krem, **67** Mat Füme gelecek şekilde sipariş verilmelidir.

Functions / Fonksiyonlar



**Shielded Tv Socket Outlet
End Of Line**
TV Prizi Ekranlı-Sonlu

510-01XX00-273



SAT Socket Outlet F Type
Uydu Prizi
(F dişi Konnektörlü)

510-01XX00-280



**Tv + Rad + SAT Socket
Outlet Through Line**
TV + Radyo + SAT-Geçişli

510-01XX00-233



**Tv + Rad + SAT Socket
Outlet End Of Line**
TV + Radyo + SAT - Sonlu

510-01XX00-234



VGA Socket
VGA Priz

510-01XX00-173



**Numeris Telephone
Socket Outlet** (RJ11 CAT3)
Nümeris Prizi (RJ11 CAT3)

510-01XX00-221



**Double Numeris Telephone
Socket Outlet** (2 x RJ11 CAT3)
İkili Nümeris Prizi
(2 x RJ11 CAT3)

510-01XX00-222



Data Socket Outlet
(RJ45 CAT6)
Data Prizi (RJ45 CAT6)

510-01XX00-247



Double Data Socket Outlet
(2 x RJ45 CAT6) İkili Data
Prizi (2 x RJ45 CAT6)

510-01XX00-248



USB Connector (Data Transfer)
USB Konnektör (Veri Transferi)

510-01XX00-242



**Data + Numeris Telephone
Socket Outlet** (RJ45 CAT6+
RJ11 CAT3) Data Prizi + Nümeris
Priz (RJ45 CAT6 + RJ11 CAT3)

510-01XX00-249



**Data + Numeris Telephone
Socket Outlet Without Jack**
Data Prizi + Nümeris Priz Jaksız

510-01XX00-260



**Numeris Socket
Without Jack**
Nümeris Prizi Jaksız

510-01XX00-282



Data Socket Without Jack
Data Prizi Jaksız

510-01XX00-296



**Music Hi-Fi Socket
Outlet 2 Gang**
İkili Müzik Yayın Prizi

510-01XX00-241



Fiber Optic Data Socket
Fiber Optik Data Prizi

510-01XX00-300



**Double Fiber Optic
Data Socket**
İkili Fiber Optik Data Prizi

510-01XX00-304



Double USB Charger 5V 2,1A
USB Şarj Prizi 5V 2,1A Çiftli

510-01XX00-143



HDMI Socket
HDMI Priz

500-01XX00-284

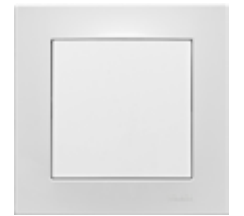

Blind Cover
Kör Kapak

510-01XX00-299

* To select color of product please replace the XX with the color code: White 02, Cream 03, Black 30, Snow White 56, Latte (Anthracite) 40, M. Grey 10, Fume 11, Titanium 14, Ivory 25, Vantablack 48, Maple 27, New Cherry 28, White Oak 42, Mahogany 29, Matt White 62, Matt Cream 65, Mat Fume 67.

* Ürün renklerini belirtmek için ürün kodundaki XX yerine; 02 Beyaz, 03 Krem, 30 Siyah, 56 Karbeyaz, 40 Latte (Antrasit), 10 M. Gri, 11 Füme, 14 Titanyum, 25 Fildişi, 48 Vantablack, 28 Yeni Kiraz, 42 Beyaz Meşe, 29 Maun, 27 Akçağaç, 62 Mat Beyaz, 65 Mat Krem, 67 Mat Füme gelecek şekilde sipariş verilmelidir.

Functions / Fonksiyonlar



**Double USB(Type C+A) Socket
Outlet Earthed Child protection**
İkili USB(Type C+A) Topraklı Priz
Çocuk Korumalı

510-01XX00-334



**Double USB Charging
Socket (Type C+A)**
USB Şarj Prizi (Type C+A) Çiftli

510-01XX00-335



Relay Motion Sensor
Röleli Hareket Sensörü

510-01XX00-262



Triac Motion Sensor
Triyaklı Hareket Sensörü

510-01XX00-264



Dimmer 500W CE
Dimmer 500W CE

510-01XX00-144



Dimmer Illuminated (1000W)
Işıklı Dimmer (1000W)

510-01XX00-192



Music Volume Control Switch
Müzik Yayın Anahtarı

510-01XX00-261



Dimmer (1000W)
Dimmer (1000W)

510-01XX00-112



**110V Ventilator Control
Switch 200W**
110V Fan Dimmer 200W

510-01XX00-277



**220V Ventilator Control
Switch 200W**
220V Fan Dimmer 200W

510-01XX00-278



RC Led dimmer 5-60W
RC Led dimmer 5-60W

510-01XX00-308



1-10V Dimmer
1-10V Dimmer

510-01XX00-316



5-300W RC Dimmer
5-300W RC Dimmer

510-01XX00-310



Optic Energy Saver Delayed
Optik Algılamalı Enerji
Saver Gecikmeli

510-01XX00-291



Rfid Energy Saver
Rfid Enerji Saver

510-01XX00-158



Rf Energy Saver
Rf Enerji Saver

510-01XX00-318



Universal Energy Saver
Üniversal Enerji Saver

510-01XX00-265



Mechanical Energy Saver
Mekanik Enerji Saver

510-01XX00-266



**Double USB Charging
HDMI Socket**
İkili USB Şarj HDMI Prizi

510-01XX00-337

* To select color of product please replace the XX with the color code: White 02, Cream 03, Black 30, Snow White 56, Latte (Anthracite) 40, M. Grey 10, Fume 11, Titanium 14, Ivory 25, Vantablack 48, Maple 27, New Cherry 28, White Oak 42, Mahogany 29, Matt White 62, Matt Cream 65, Mat Fume 67.

* Ürün renklerini belirtmek için ürün kodundaki XX yerine; 02 Beyaz, 03 Krem, 30 Siyah, 56 Karbeyaz, 40 Latte (Antrasit), 10 M. Gri, 11 Füme, 14 Titanyum, 25 Fildişi, 48 Vantablack, 28 Yeni Kiraz, 42 Beyaz Meşe, 29 Maun, 27 Akçağaç, 62 Mat Beyaz, 65 Mat Krem, 67 Mat Füme gelecek şekilde sipariş verilmelidir.

Gang Frames / Çoklu Çerçeveler



Single Frame / Tekli Çerçeve
510-01XX00-271



2 Gang Frame / İkilik Çerçeve
510-01XX00-226



3 Gang Frame / Üçlü Çerçeve
510-01XX00-227

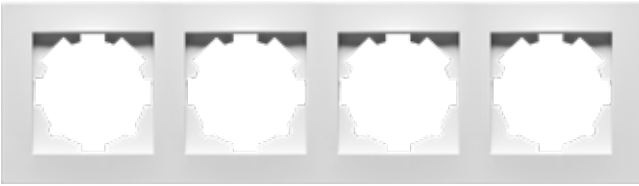

4 Gang Frame / Dörtlük Çerçeve
510-01XX00-228



5 Gang Frame / Beşli Çerçeve
510-01XX00-250

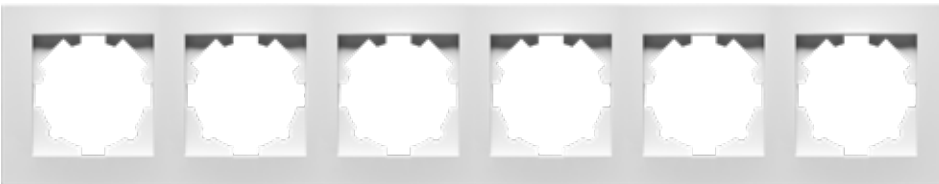

6 Gang Frame / Altılı Çerçeve
510-01XX00-252



Double Socket Outlet Without Earthed
İkili Sıva Altı Priz

510-01XX30-908



Double Socket Outlet Earthed
İkili Sıva Altı Topraklı Priz

510-01XX30-907



Flush Mounted 3G Earthed Socket Outlet
Sıvaaltı Üçlü Topraklı Priz

500-00XX00-819

*only natural and silverline series.

*sadece natural ve silverline serilerimizdedir.

◆ Multiple frames can be used horizontally and vertically. / Çoklu çerçeveler yatay ve dikey olarak kullanılabilir.

* To select color of product please replace the XX with the color code: White 02, Cream 03, Black 30, Snow White 56, Latte (Anthracite) 40, M. Grey 10, Fume 11, Titanium 14, Ivory 25, Vantablack 48, Maple 27, New Cherry 28, White Oak 42, Mahogany 29, Matt White 62, Matt Cream 65, Mat Fume 67.

* Ürün renklerini belirtmek için ürün kodundaki XX yerine; 02 Beyaz, 03 Krem, 30 Siyah, 56 Karbeyaz, 40 Latte (Antrasit), 10 M. Gri, 11 Füme, 14 Titanyum, 25 Fildişi, 48 Vantablack, 28 Yeni Kiraz, 42 Beyaz Meşe, 29 Maun, 27 Akçaağaç, 62 Mat Beyaz, 65 Mat Krem, 67 Mat Füme gelecek şekilde sipariş verilmelidir.

jazz

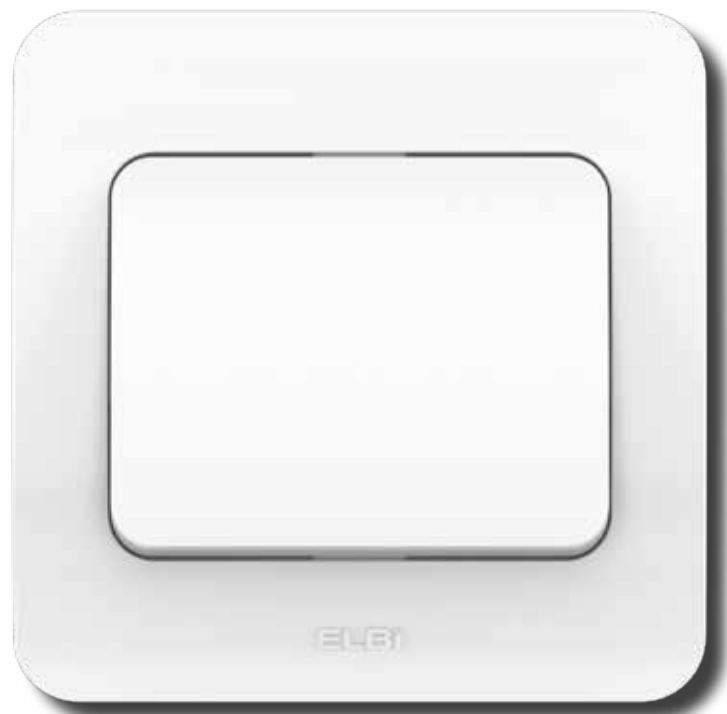

ELBI
ELECTRIC

Montage Schema / Montaj Şeması

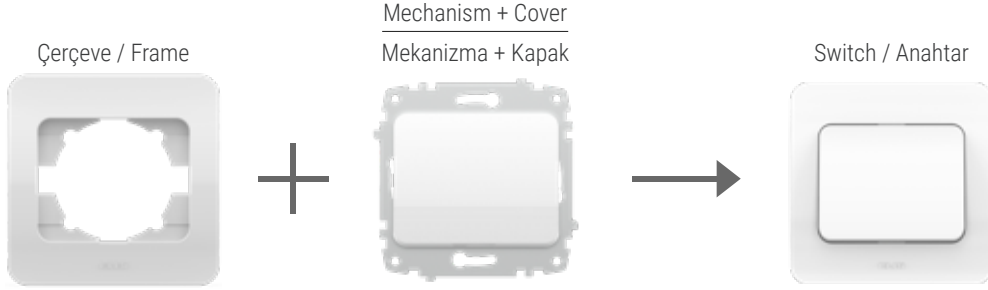

Frame Size / Çerçeve Ebatları

Single Frame / Tekli Çerçeve
508-01XX00-271

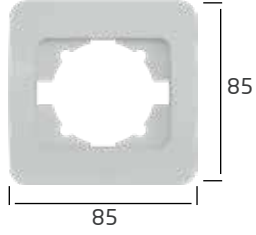

6 Gang Frame / Altılı Çerçeve
508-01XX00-252

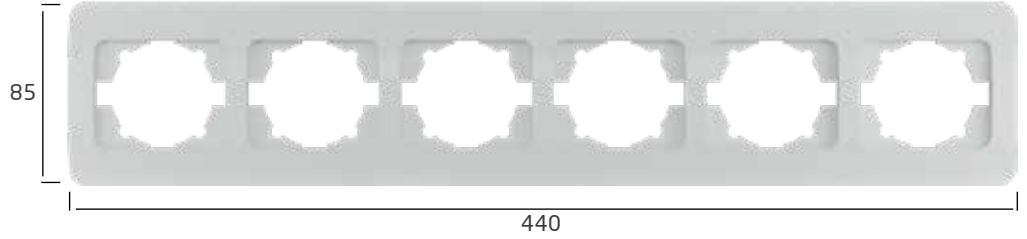

2 Gang Frame / İkili Çerçeve
508-01XX00-226

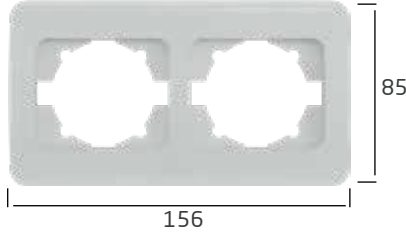

5 Gang Frame / Beşli Çerçeve
508-01XX00-250

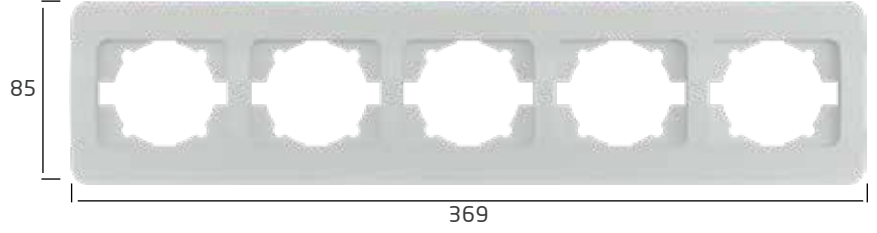

3 Gang Frame / Üçlü Çerçeve
508-01XX00-227

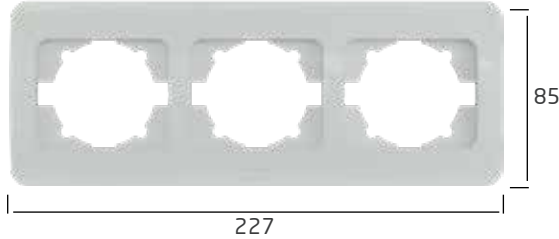

4 Gang Frame / Dörtlü Çerçeve
508-01XX00-228

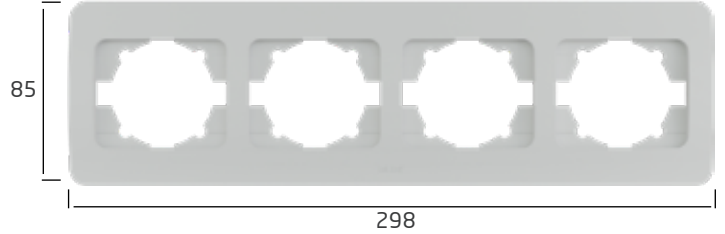

* To select color of product please replace the XX with the color code: White 02, Cream 03, Vantablack 48, Titanium 14, Smoke Grey 74, Basalt 61, Antique Walnut 04, Cherry 06, Beech 07, Matt White 62, Matt Cream 65, Mat Fume 67.

* Ürün renklerini belirtmek için ürün kodundaki XX yerine; 02 Beyaz, 03 Krem, 48 Vantablack, 14 Titanyum, 74 Duman Grisi, 61 Bazalt, 04 Antik Ceviz, 06 Kiraz, 07 Kayın, 62 Mat Beyaz, 65 Mat Krem, 67 Mat Füme gelecek şekilde sipariş verilmelidir.

Color Options / Renk Seçenekleri

jazznatural



WHITE
BEYAZ

508-010200-200



CREAM
KREM

508-010300-200

jazzsilverline



VANTABLACK

508-014800-200



TITANIUM
TİTANYUM

508-011400-200



SMOKE GREY
DUMAN GRİSİ

508-017400-200



BASALT
BAZALT

508-016100-200

jazzwoodline



ANTIQUE WALNUT
ANTİK CEVİZ

508-010400-200



CHERRY
KIRAZ

508-010600-200



BEECH
KAYIN

508-010700-200

jazzpastel



MATT WHITE
MAT BEYAZ

508-016200-200



MATT CREAM
MAT KREM

508-016500-200



MATT FUME
MAT FÜME

508-016700-200

* To select color of product please replace the XX with the color code: White 02, Cream 03, Vantablack 48, Titanium 14, Smoke Grey 74, Basalt 61, Antique Walnut 04, Cherry 06, Beech 07, Matt White 62, Matt Cream 65, Mat Fume 67.

* Ürün renklerini belirtmek için ürün kodundaki XX yerine; 02 Beyaz, 03 Krem, 48 Vantablack, 14 Titanyum, 74 Duman Grisi, 61 Bazalt, 04 Antik Ceviz, 06 Kiraz, 07 Kayın, 62 Mat Beyaz, 65 Mat Krem, 67 Mat Füme gelecek şekilde sipariş verilmelidir.

Functions / Fonksiyonlar



1Gang 1Way Switch
Anahtar

508-01XX00-200



1Gang 1Way Switch
Illuminated
Işıklı Anahtar

508-01XX00-201

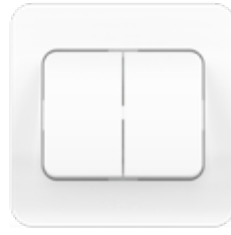

2Gang 1Way Switch
Komütatör

508-01XX00-202



2Gang 1Way Switch
Illuminated
Işıklı Komütatör

508-01XX00-203

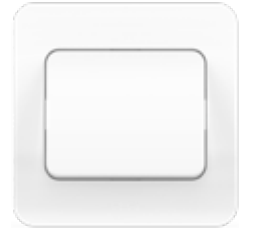

Control Switch Door
Kapı Otomatığı

508-01XX00-204



Control Switch Light
Light Anahtarı

508-01XX00-205



Control Switch
Illuminated Light
Işıklı Light Anahtar

508-01XX00-206



Control Switch Bell
Zil Anahtarı

508-01XX00-207

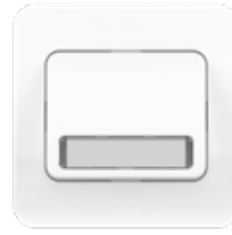

12V Illuminated Labelled
Control Switch Bell
12V Işıklı İsimli Zil

508-01XX00-208



1Gang 2Way Switch
Vavien

508-01XX00-209



1 Gang 2 Way
Switch Illuminated
Işıklı Vavien

508-01XX00-210

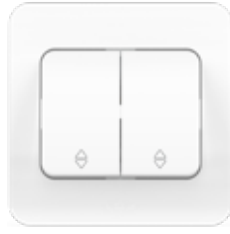

2 Gang 2 Way Switch
Komütatör Vavien

508-01XX00-211



1 Gang 2 Way
Switch Intermediate
Ara Vavien (Permütatör)

508-01XX00-214



Blind Switch
Jaluzi Kumanda Anahtarı

508-01XX00-216



Double Pole Switch
Illuminated
İki Kutuplu Işıklı Anahtar

508-01XX00-236

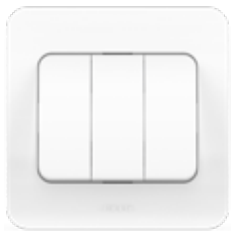

3 Gang 1 Way Switch
Üçlü Anahtar

508-01XX00-254



2 Gang 1 Way
Control Switch Light
Komütatör Light

508-01XX00-257



Double Pole Switch
İki Kutuplu Anahtar

508-01XX00-269

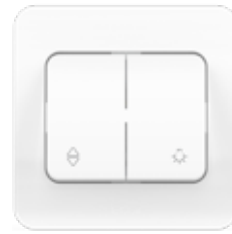

Vavien + Light Switch
Vavien + Light Anahtar

508-01XX00-281

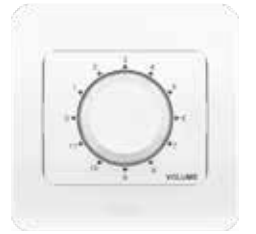

Music Volume Control Switch
Müzik Yayın Anahtarı

508-01XX00-261

* To select color of product please replace the XX with the color code: White 02, Cream 03, Vantablack 48, Titanium 14, Smoke Grey 74, Basalt 61, Antique Walnut 04, Cherry 06, Beech 07, Matt White 62, Matt Cream 65, Mat Fume 67.

* Ürün renklerini belirtmek için ürün kodundaki XX yerine; 02 Beyaz, 03 Krem, 48 Vantablack, 14 Titanyum, 74 Duman Grisi, 61 Bazalt, 04 Antik Ceviz, 06 Kiraz, 07 Kayın, 62 Mat Beyaz, 65 Mat Krem, 67 Mat Fume gelecek şekilde sipariş verilmelidir.

Functions / Fonksiyonlar



SAT Socket Outlet F Type
(RG 6 F Connector)
Uydu Prizi (RG 6 F Connector)

508-01XX00-180



SAT Socket Outlet F Type
Through Line
Uydu prizi geçişli
(F dişi Konnektörü)

508-01XX00-287



SAT Socket Outlet F Type
End Of Line
Uydu prizi sonlu
(F dişi Konnektörü)

508-01XX00-288



Tv + SAT Socket Outlet
Through Line
TV + SAT Prizi - Geçişli

508-01XX00-289



Tv + SAT Socket Outlet
End Of Line
TV + SAT Prizi - Sonlu

508-01XX00-290



Socket Outlet
Without Earthed
Priz

508-01XX00-215



Socket Outlet
Earthed
Topraklı Priz

508-01XX00-217



Socket Outlet Earthed
With Hinged Lid
Kapaklı Topraklı Priz

508-01XX00-218



Socket Outlet Earthed
ChildProtection
Çocuk Korumalı Topraklı Priz

508-01XX00-243



Socket Outlet Earthed Child
Protection With Hinged Lid
Çocuk Korumalı Kapaklı
Topraklı Priz

508-01XX00-219



Ups Socket Outlet
With Earthed Pin
UPS Priz

508-01XX00-268



Child Protection Ups
Socket Outlet Earthed Pin
Çocuk Korumalı UPS Priz

508-01XX00-263

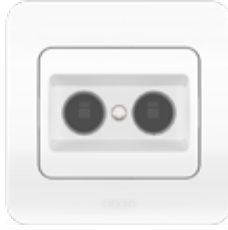

Music Hi-Fi Socket
Outlet 2 Gang
İkili Müzik Yayın Prizi

508-01XX00-241



USB Connector (Data Transfer)
USB Konnektör (Veri Transferi)

508-01XX00-242



Numeris Telephone
Socket Outlet (RJ11 CAT3)
Nümeris Prizi (RJ11 CAT3)

508-01XX00-221

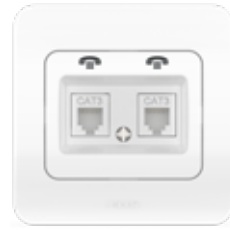

Double Numeris Telephone
Socket Outlet (2 x RJ11 CAT3)
İkili Nümeris Prizi
(2 x RJ11 CAT3)

508-01XX00-222



Data Socket Outlet
(RJ45 CAT6)
Data Prizi (RJ45 CAT6)

508-01XX00-247



Double Data Socket Outlet
(2 x RJ45 CAT6) İkili Data
Prizi (2 x RJ45 CAT6)

508-01XX00-248



Data + Numeris Telephone
Socket Outlet (RJ45 CAT6+
RJ11 CAT3) Data Prizi + Nümeris
Priz (RJ45 CAT6 + RJ11 CAT3)

508-01XX00-249



Fiber Optic Data Socket
Fiber Optik Data Prizi

508-01XX00-300

* To select color of product please replace the XX with the color code: White 02, Cream 03, Vantablack 48, Titanium 14, Smoke Grey 74, Basalt 61, Antique Walnut 04, Cherry 06, Beech 07, Matt White 62, Matt Cream 65, Mat Fume 67.

* Ürün renklerini belirtmek için ürün kodundaki XX yerine; 02 Beyaz, 03 Krem, 48 Vantablack, 14 Titanyum, 74 Duman Grisi, 61 Bazalt, 04 Antik Ceviz, 06 Kiraz, 07 Kayın, 62 Mat Beyaz, 65 Mat Krem, 67 Mat Füme gelecek şekilde sipariş verilmelidir.

Functions / Fonksiyonlar



Double Fiber Optic Data Socket
İkili Fiber Optik Data Prizi

508-01XX00-304



HDMI Socket
HDMI Priz

508-01XX00-284

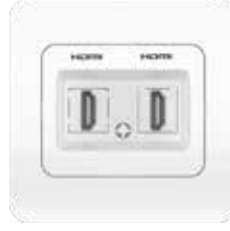

Double HDMI Socket
İkili HDMI Priz

508-01XX00-336



HDMI + USB Socket
HDMI + USB Priz

508-01XX00-337



Data + Numeris Telephone Socket Outlet Without Jack
Data Prizi + Nümeris Priz Jaksız

510-01XX00-260

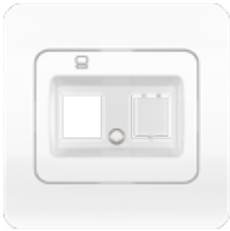

Data Socket Without Jack
Data Prizi Jaksız

508-01XX00-296



Cable Outlet Cover
Kablo Çıkış Kapağı

508-01XX00-298



Dimmer (1000W)
Dimmer (1000W)

508-01XX00-112



Dimmer Illuminated (1000W)
Işıklı Dimmer (1000W)

508-01XX00-192



RC Led dimmer 5-60W
RC Led dimmer 5-60W

508-01XX00-308



5-300W RC Dimmer
5-300W RC Dimmer

508-01XX00-310



1-10V Dimmer
1-10V Dimmer

508-01XX00-316



Tv + Rad + SAT Socket Outlet End Of Line
TV + Radyo + SAT - Sonlu

508-01XX00-234



TV Socket Outlet Through Line
TV Priz - Geçişli

508-01XX00-224



Shielded Tv Socket Outlet Through Line
TV Prizi Ekranlı-Geçişli

508-01XX00-272



3Gang 1Way Hvac Switch
3'lü Klima Anahtarı

508-01XX00-279



220V Ventilator Control Switch 200W
220V Fan Dimmer 200W

508-01XX00-278



Air Conditioner Switch 25A
25A Klima Anahtarı

508-01XX00-275



TV Socket- without card
Tv Priz - Kartsız

508-00XX00-270



British Type Socket Outlet Earthed
İngiliz Tipi Topraklı Priz

508-01XX00-294

* To select color of product please replace the XX with the color code: White 02, Cream 03, Vantablack 48, Titanium 14, Smoke Grey 74, Basalt 61, Antique Walnut 04, Cherry 06, Beech 07, Matt White 62, Matt Cream 65, Mat Fume 67.

* Ürün renklerini belirtmek için ürün kodundaki XX yerine; 02 Beyaz, 03 Krem, 48 Vantablack, 14 Titanyum, 74 Duman Grisi, 61 Bazalt, 04 Antik Ceviz, 06 Kiraz, 07 Kayın, 62 Mat Beyaz, 65 Mat Krem, 67 Mat Füme gelecek şekilde sipariş verilmelidir.

Functions / Fonksiyonlar



**TV + Radio Socket Outlet
Through Line**
Tv-Radyo Prizi-Geçişli

508-00XX00-220



Telephone Socket Outlet
Telefon Priz

508-00XX00-223



Data Socket Cat5
Data Prizi Cat5

508-00XX00-229



Music Hi Fi Socket Outlet
Müzik Yayın Prizi

508-00XX00-235



Energy Saver
Enerji Saver

508-00XX00-267



Energy Saver Optic
Energy Saver Optik Algılamalı

510-00XX00-258



Rfid Energy Saver
Rfid Enerji Saver

508-01XX00-158



Rf Energy Saver
Rf Enerji Saver

508-01XX00-318



Double UPS Socket Outlet
İkili Sıva Altı UPS Priz

508-01XX30-906



Double Socket Outlet Earthed
İkili Sıva Altı Topraklı Priz

508-01XX30-907



Double Socket Outlet Without Earthed
İkili Sıva Altı Priz

508-01XX30-908



**Child Protection Double
UPS Socket Outlet**
Çocuk Korumalı İkili Sıva Altı UPS Priz

508-01XX00-916



**Child Protection Double
Socket Outlet Earthed**
Çocuk Korumalı İkili Sıva Altı Topraklı Priz

508-01XX00-917



**Child Protection Double
Socket Outlet Without Earthed**
Çocuk Korumalı İkili Sıva Altı Priz

508-01XX00-918

* To select color of product please replace the XX with the color code: White 02, Cream 03, Vantablack 48, Titanium 14, Smoke Grey 74, Basalt 61, Antique Walnut 04, Cherry 06, Beech 07, Matt White 62, Matt Cream 65, Mat Fume 67.

* Ürün renklerini belirtmek için ürün kodundaki XX yerine; 02 Beyaz, 03 Krem, 48 Vantablack, 14 Titanyum, 74 Duman Grisi, 61 Bazalt, 04 Antik Ceviz, 06 Kiraz, 07 Kayın, 62 Mat Beyaz, 65 Mat Krem, 67 Mat Füme gelecek şekilde sipariş verilmelidir.

Functions / Fonksiyonlar



Single Frame / Tekli Çerçeve
508-01XX00-271

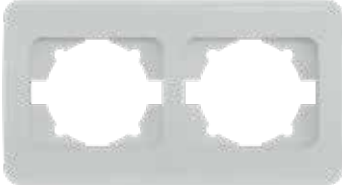

2 Gang Frame / İkilik Çerçeve
508-01XX00-226

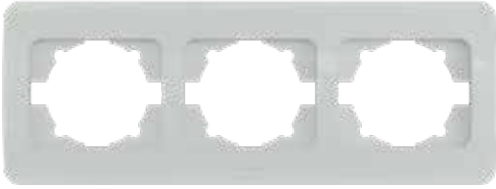

3 Gang Frame / Üçlü Çerçeve
508-01XX00-227



4 Gang Frame / Dörtlü Çerçeve
508-01XX00-228



5 Gang Frame / Beşli Çerçeve
508-01XX00-250

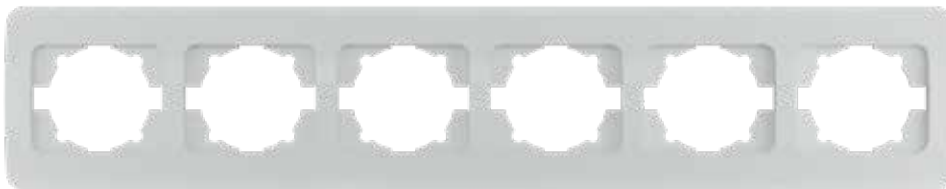

6 Gang Frame / Altılı Çerçeve
508-01XX00-252

* To select color of product please replace the XX with the color code: White 02, Cream 03, Vantablack 48, Titanium 14, Smoke Grey 74, Basalt 61, Antique Walnut 04, Cherry 06, Beech 07, Matt White 62, Matt Cream 65, Mat Fume 67.

* Ürün renklerini belirtmek için ürün kodundaki XX yerine; 02 Beyaz, 03 Krem, 48 Vantablack, 14 Titanyum, 74 Duman Grisi, 61 Bazalt, 04 Antik Ceviz, 06 Kiraz, 07 Kayın, 62 Mat Beyaz, 65 Mat Krem, 67 Mat Füme gelecek şekilde sipariş verilmelidir.

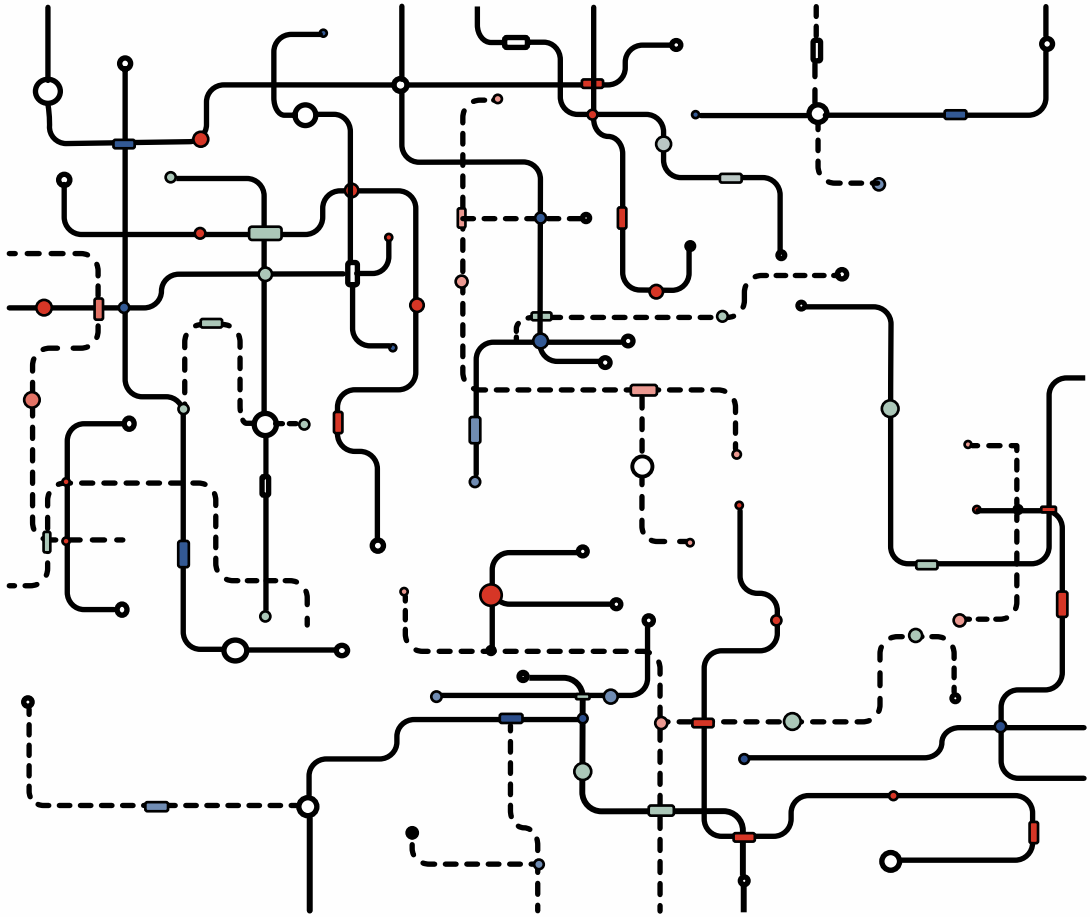

Technical Information

Teknik Bilgiler

Zena Vega Jazz Connect Schemas / Zena Vega Jazz Bağlantı Şemaları

1Gang 1Way Switch
Anahtar
XXX-XXXXXX-200

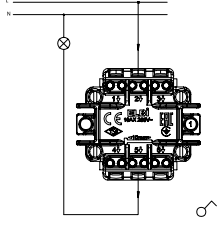
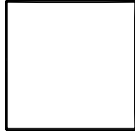

1Gang 1Way Switch Illuminated
Işıklı Anahtar
XXX-XXXXXX-201

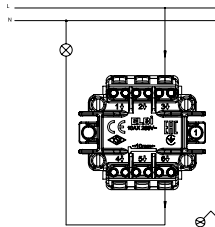
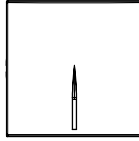

2Gang 1Way Switch
Komütatör
XXX-XXXXXX-202

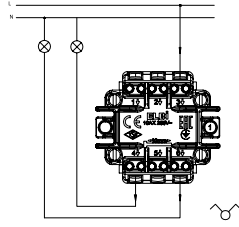
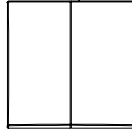

2Gang 1Way Switch Illuminated
Işıklı Komütatör
XXX-XXXXXX-203

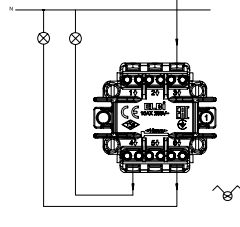
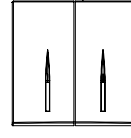

Control Switch Door
Kapı Otomatığı
XXX-XXXXXX-204

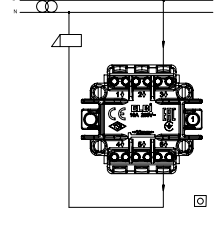
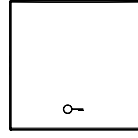

Control Switch Light
Light Anahtar
XXX-XXXXXX-205

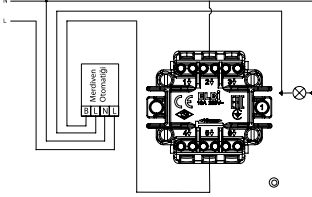
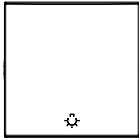

Control Switch Illuminated Light
Işıklı Light Anahtar
XXX-XXXXXX-206

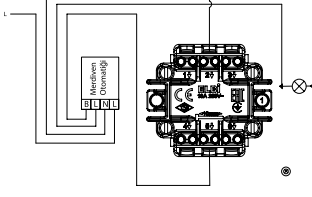
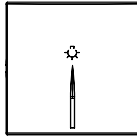

Control Switch Bell
Zil Anahtar
XXX-XXXXXX-207

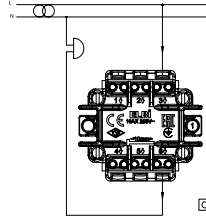
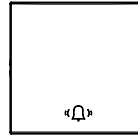

12V Illuminated Labelled Control Switch Bell
12V Işıklı İsimli Zil Anahtar
XXX-XXXXXX-208

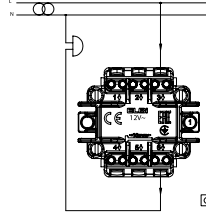
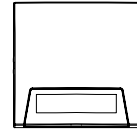

1Gang 2Way Switch
Veavien
XXX-XXXXXX-209

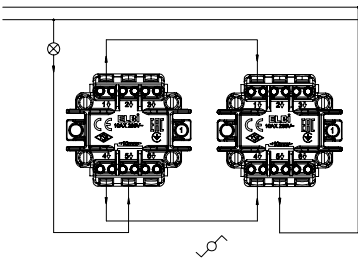
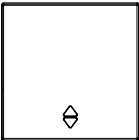

1Gang 2Way Illuminated Switch
Işıklı Veavien
XXX-XXXXXX-210

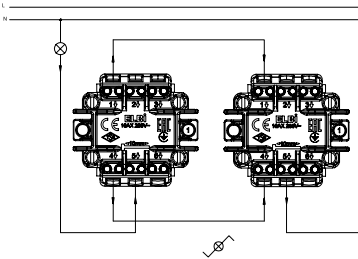
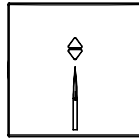

2Gang 2Way Switch
Komütatör Veavien
XXX-XXXXXX-211

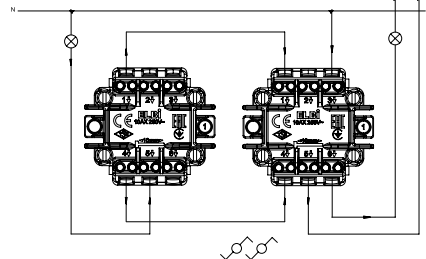
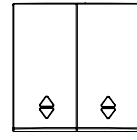

1Gang 2Way Switch Intermediate
Ara Veavien (Permutatör)
XXX-XXXXXX-214

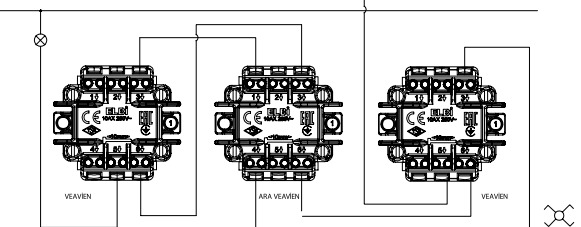
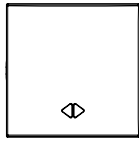

3Gang 1Way Switch
Uçlu Anahtar
XXX-XXXXXX-254

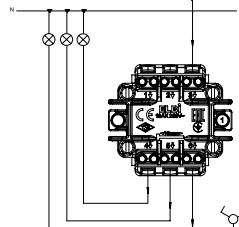
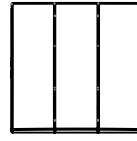

2Gang 1Way Control Switch Light
Komütatör Light
XXX-XXXXXX-257

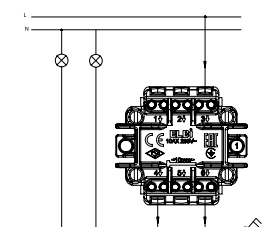
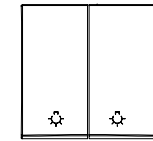

Zena Vega Jazz Connect Schemas / Zena Vega Jazz Bağlantı Şemaları

3Gang 1Way Hvac Switch
3'lü Klima Anahtarı
XXX-XXXXXX-279

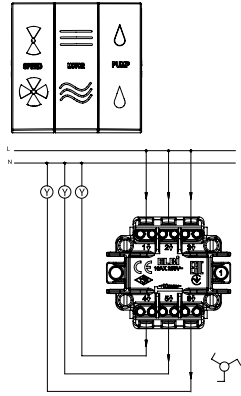

Dimmer Illuminated (1000W)
Işıklı Dimmer (1000W)
XXX-XXXXXX-192

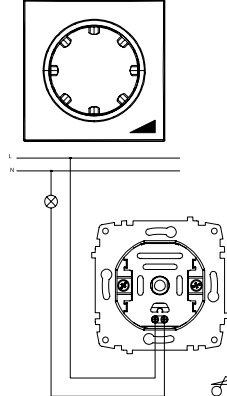

Dimmer (1000W)
Dimmer (1000W)
XXX-XXXXXX-112

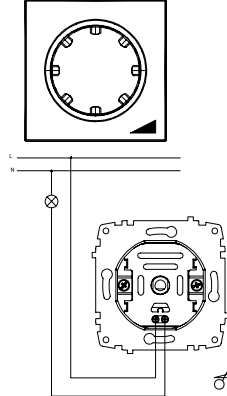

RC Led Dimmer (5-60W)
RC Led Dimmer (5-60W)
XXX-XXXXXX-308

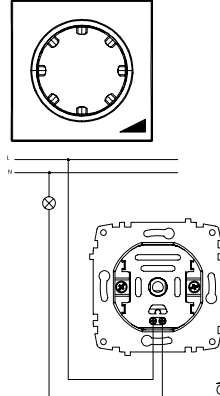

RC Led Dimmer (5-300W)
RC Led Dimmer (5-300W)
XXX-XXXXXX-310

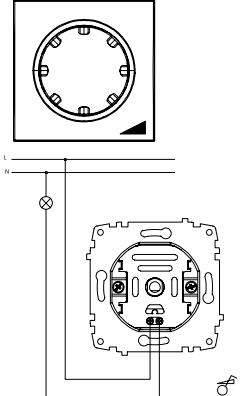

Dimmer 500W CE
Dimmer 500W CE
XXX-XXXXXX-144

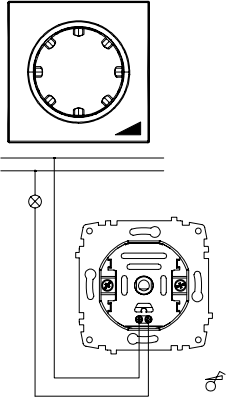

Double USB Charger 5V 2,1A
USB Sarj Prizi 5V 2,1A Çiftli
XXX-XXXXXX-143

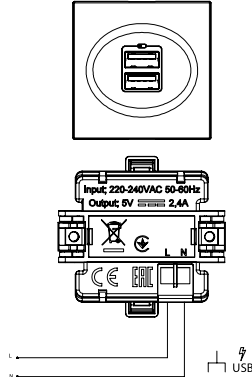

VGA Socket
VGA Priz
XXX-XXXXXX-173

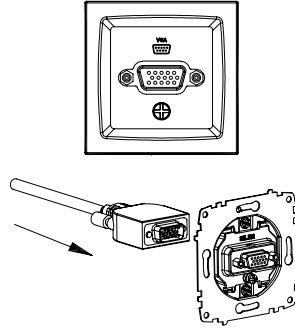

Dimmer 1-10V
Dimmer 1-10V
XXX-XXXXXX-316

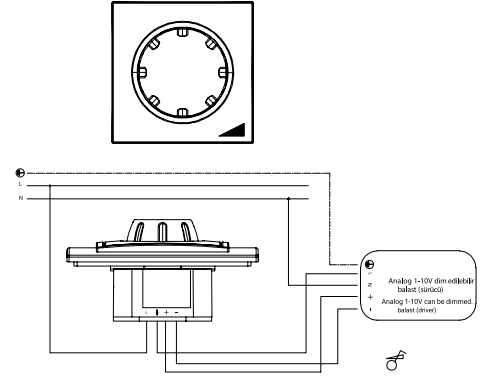

SAT Socket Outlet F Type (Rg6 F Connector)
Uydu Prizi (Rg6 F Konnektörlü)
XXX-XXXXXX-180

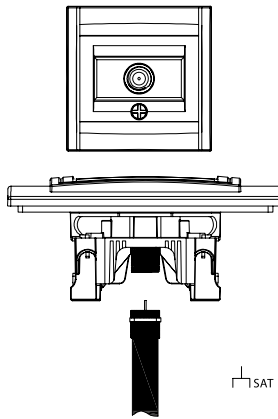

RFID Energy Saver
RFID Energy Saver
XXX-XXXXXX-158

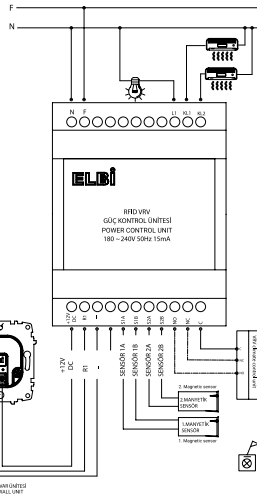
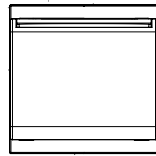

Music Volume Control Switch
Müzik Yayın Anahtarı
XXX-XXXXXX-261

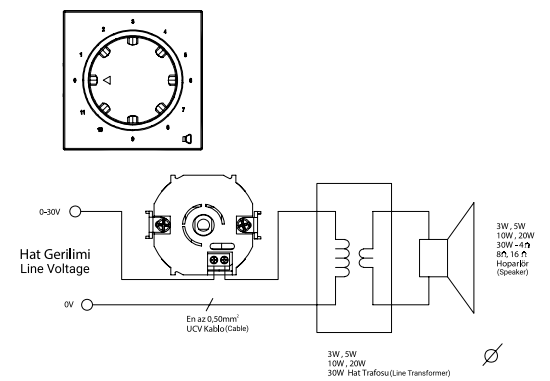

Socket Outlet Without Earthed
Priz
XXX-XXXXXX-215

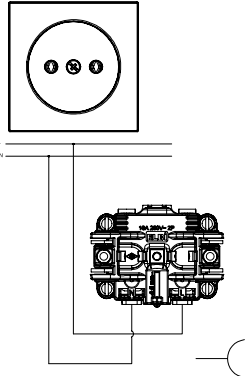

Socket Outlet Earthed
Topraklı Priz
XXX-XXXXXX-217

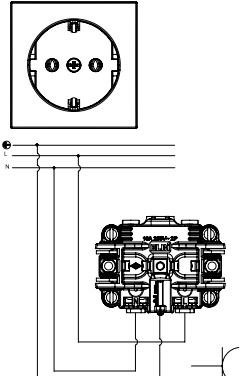

Child Protection Socket
Without Earthed
Çocuk Korumalı Priz
XXX-XXXXXX-286

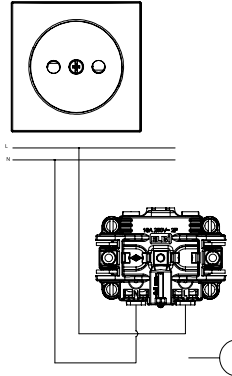

Child Protection UPS Socket
Outlet Earthed Pin
Çocuk Korumalı UPS Priz
XXX-XXXXXX-263

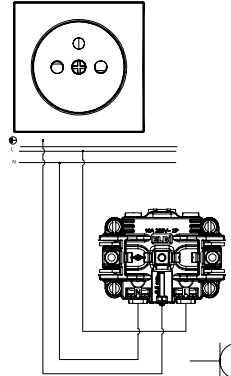

UPS Socket Outlet With
Earthed Pin
UPS Priz
XXX-XXXXXX-268

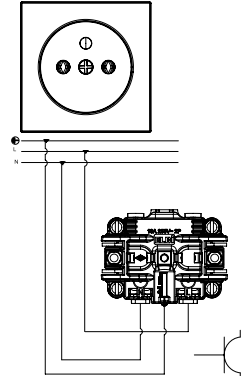

Zena Vega Jazz Connect Schemas / Zena Vega Jazz Bağlantı Şemaları

Socket Outlet Earthed With Hinged Lid
Kapaklı Topraklı Priz
XXX-XXXXXX-218

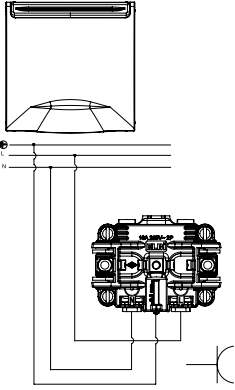

Socket Outlet Earthed Child Protection With Hinged Lid
Çocuk Korumalı Kapaklı Topraklı Priz
XXX-XXXXXX-219

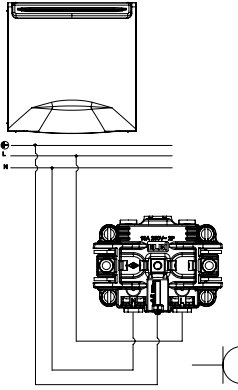

Socket Outlet Earthed Child Protection
Çocuk Korumalı Topraklı Priz
XXX-XXXXXX-243

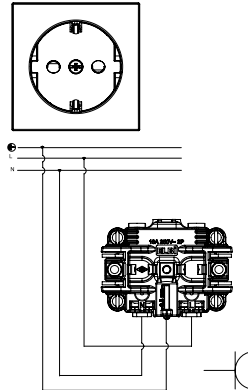

Relay Motion Sensor
Röleli Hareket Sensörü
XXX-XXXXXX-262

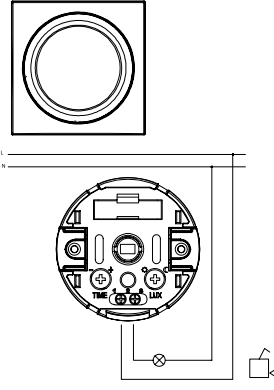

Triac Motion Sensor
Triyaklı Hareket Sensörü
XXX-XXXXXX-264

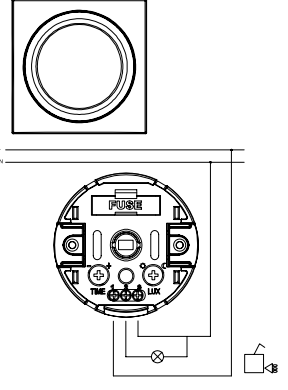

Blind Switch
Jaluzi Kumanda Anahtarı
XXX-XXXXXX-216

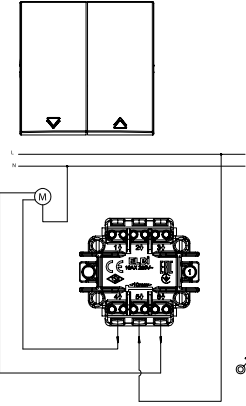

Double Numeris Telephone Socket Outlet (2 x RJ11 CAT3)
İkili Nümeris Priz (2 x RJ11 CAT3)
XXX-XXXXXX-222

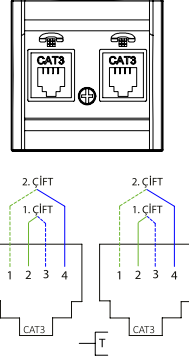

Numeris Telephone Socket Outlet (RJ11 CAT3)
Nümeris Priz (RJ11 CAT3)
XXX-XXXXXX-221

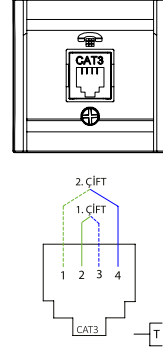

TV Socket Outlet Through Line
TV Priz - Geçişli
XXX-XXXXXX-224

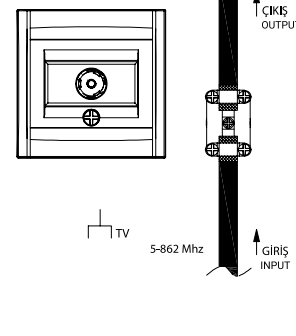

TV Socket Outlet End Of Line
TV Priz - Sonlu
XXX-XXXXXX-246

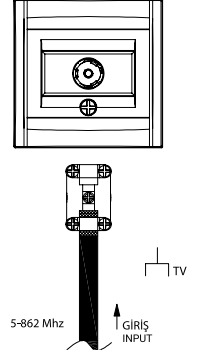

TV + Rad + SAT Socket Outlet Through Line
TV + Rad + SAT - Geçişli
XXX-XXXXXX-233



TV + Rad + SAT Socket Outlet End Of Line
TV + Rad + SAT - Sonlu
XXX-XXXXXX-234

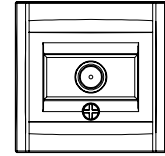

Shielded TV Socket Outlet Through Line
TV Prizi Ekranlı - Geçişli
XXX-XXXXXX-272

Other Socket Diğer Priz

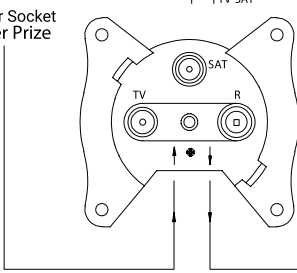

Signal Source Sinyal Kaynağı

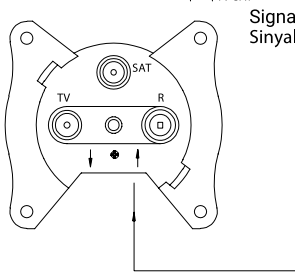

Signal Source Sinyal Kaynağı

SIGNAL INPUT SİNYAL GİRİŞİ

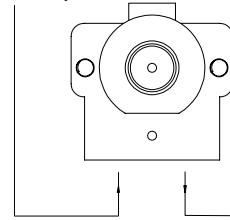

OTHER SOCKET DİĞER PRİZE

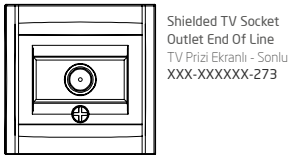

Shielded TV Socket Outlet End Of Line
TV Prizi Ekranlı - Sonlu
XXX-XXXXXX-273

SIGNAL INPUT SİNYAL GİRİŞİ

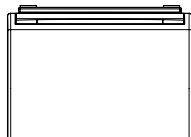
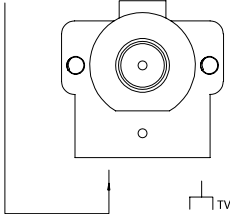

Universal Energy Saver
Üniversal Enerji Saver
XXX-XXXXXX-265

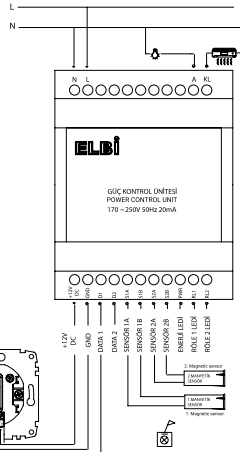

Music Hi-Fi Socket 2 Gang
İkili Müzik Yayın Prizi
XXX-XXXXXX-241

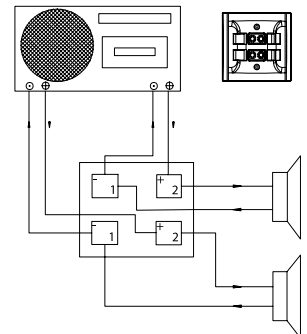
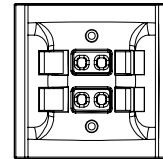

Zena Vega Jazz Connect Schemas / Zena Vega Bağlantı Şemaları

Data Socket Outlet (RJ45 CAT6)
Data Prizi (RJ45 CAT6)
XXX-XXXXXX-247

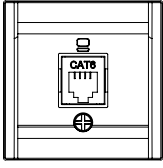

Connection Options
TIA - 568 Bağlantı Seçenekleri

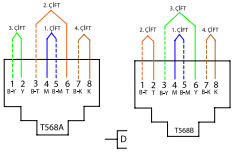

Double Data Socket
Outlet (2 x RJ45 CAT6)
İkili Data Prizi (2 x RJ45 CAT6)
XXX-XXXXXX-248

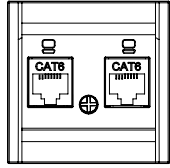

Connection Options
TIA - 568 Bağlantı Seçenekleri

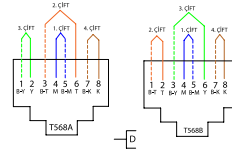

Data + Numeris Telephone Socket Outlet
(RJ45 CAT6 + RJ11 CAT3)
Data Prizi + Nümeris Priz (RJ45 CAT6 + RJ11 CAT3)
XXX-XXXXXX-249

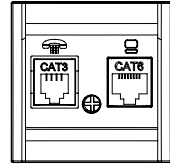

Connection Options
TIA - 568 Bağlantı Seçenekleri

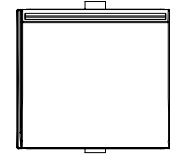
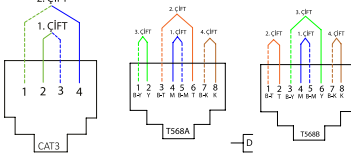

Mechanical Energy Saver
Mekanik Enerji Saver
XXX-XXXXXX-266

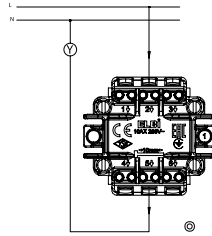

Double Pole Switch Illuminated
İki Kutuplu Işıklı Anahtar
XXX-XXXXXX-236

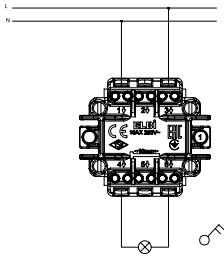
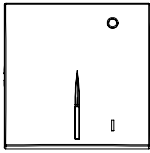

Double Pole Switch
İki Kutuplu Anahtar
XXX-XXXXXX-269

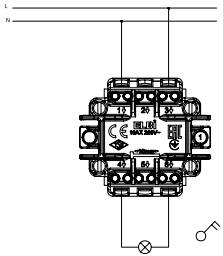
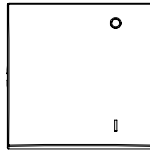

Vavien + Light Switch
Vavien + Light Anahtar
XXX-XXXXXX-281

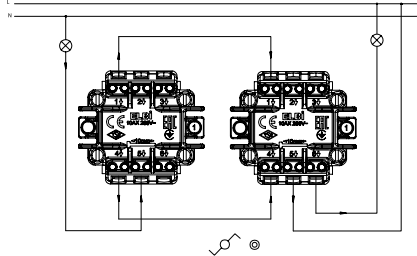
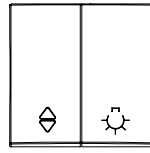

HDMI Socket
HDMI Priz
XXX-XXXXXX-284

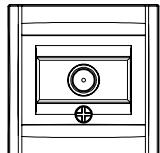
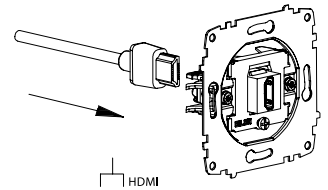
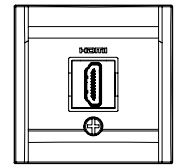

SAT Socket Outlet F Type
Through Line (F Connector)
Uydu Prizi - Geçişli (F Konnektörü)
XXX-XXXXXX-287

SIGNAL INPUT
SİNYAL GİRİŞİ

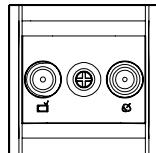
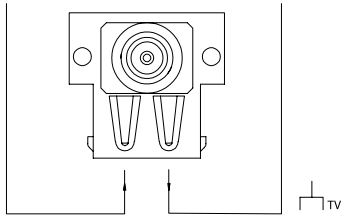

TV + SAT Socket Outlet Through Line
TV + SAT Priz - Geçişli
XXX-XXXXXX-289

OTHER SOCKET
DİĞER PRİZE

OTHER SOCKET
Diğer Prize

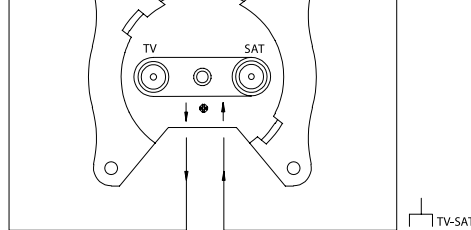

Signal Source
Sinyal Kaynağı

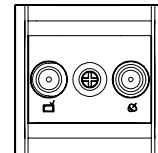

TV + SAT Socket Outlet End Of Line
TV + SAT Priz - Sonlu
XXX-XXXXXX-290

Signal Source
Sinyal Kaynağı

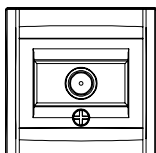
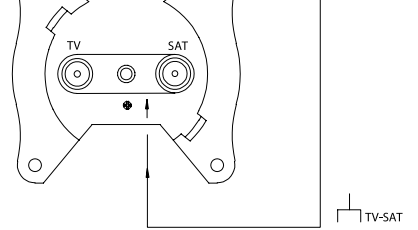

SAT Socket Outlet F Type
End Of Line (F Connector)
Uydu Prizi - Sonlu (F Konnektörü)
XXX-XXXXXX-288

SIGNAL INPUT
SİNYAL GİRİŞİ

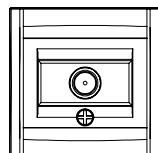
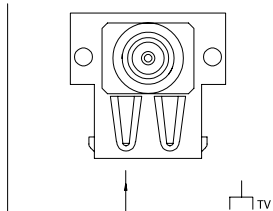

Shielded TV Socket Outlet
Without Resistance
Tv Prizi Ekranlı - Direncsiz
XXX-XXXXXX-274

SIGNAL INPUT
SİNYAL GİRİŞİ

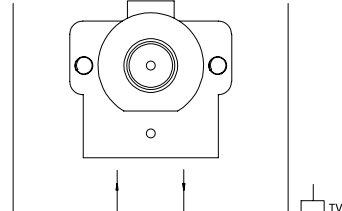

OTHER SOCKET
DİĞER PRİZE

220V Ventilator Control Switch 200W
220V Fan Dimmer 200W
XXX-XXXXXX-278

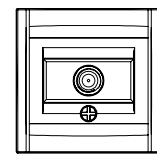
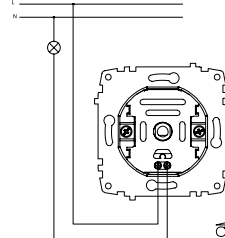
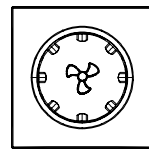

SAT Socket Outlet F Type
Uydu Prizi (F Dişi Konnektörü)
XXX-XXXXXX-280

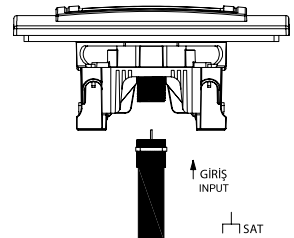

Zena Vega Jazz Connect Schemas / Zena Vega Jazz Bağlantı Şemaları

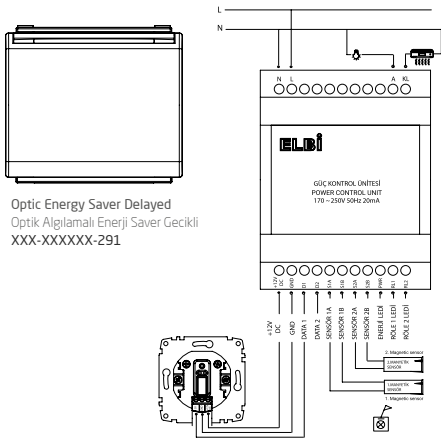

Optic Energy Saver Delayed
Optik Algılamalı Enerji Saver Gecikli
XXX-XXXXXX-291

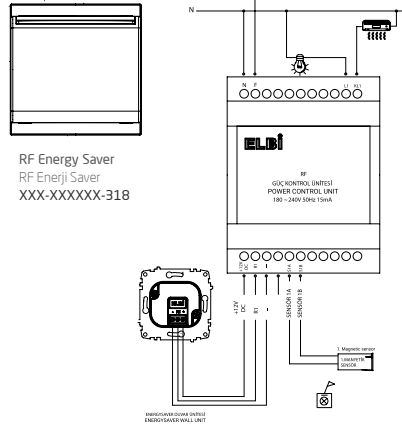

RF Energy Saver
RF Enerji Saver
XXX-XXXXXX-318

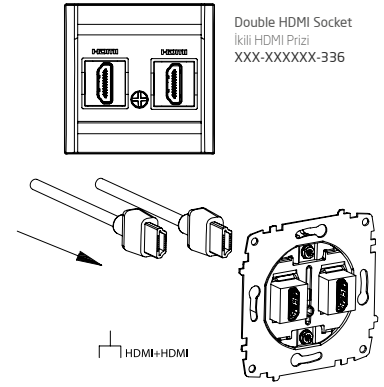

Double HDMI Socket
İkili HDMI Prizi
XXX-XXXXXX-336

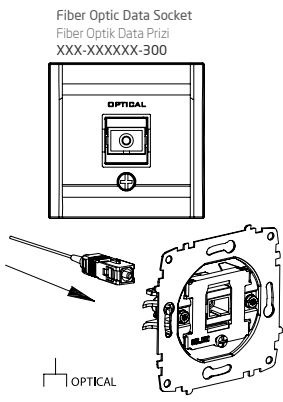

Fiber Optic Data Socket
Fiber Optik Data Prizi
XXX-XXXXXX-300

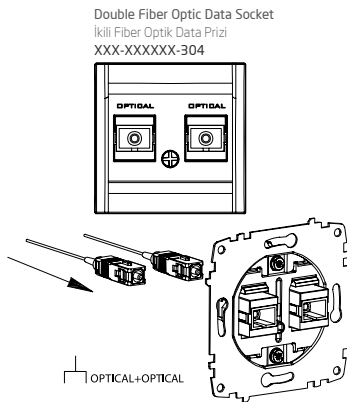

Double Fiber Optic Data Socket
İkili Fiber Optik Data Prizi
XXX-XXXXXX-304

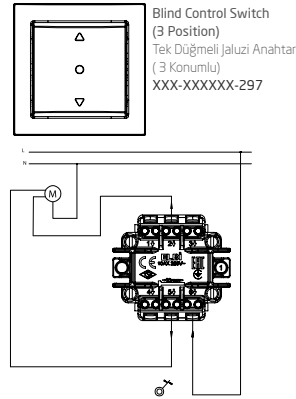

Blind Control Switch
(3 Position)
Tek Düğmeli Jalu Anahtarı
(3 Konumlu)
XXX-XXXXXX-297

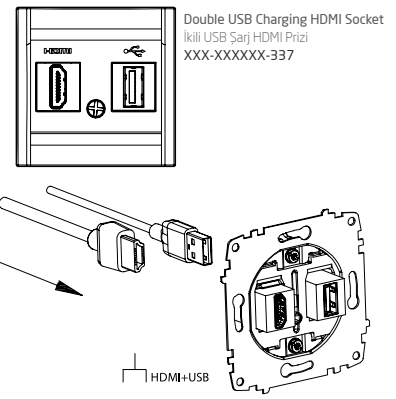

Double USB Charging HDMI Socket
İkili USB Şarj HDMI Prizi
XXX-XXXXXX-337

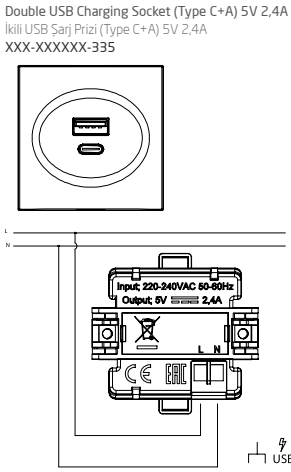

Double USB Charging Socket (Type C+A) 5V 2,4A
İkili USB Şarj Prizi (Type C+A) 5V 2,4A
XXX-XXXXXX-335

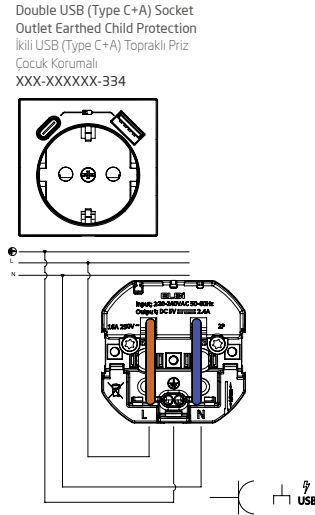

Double USB (Type C+A) Socket
Outlet Earthed Child Protection
İkili USB (Type C+A) Topraklı Priz
Çocuk Korumalı
XXX-XXXXXX-334

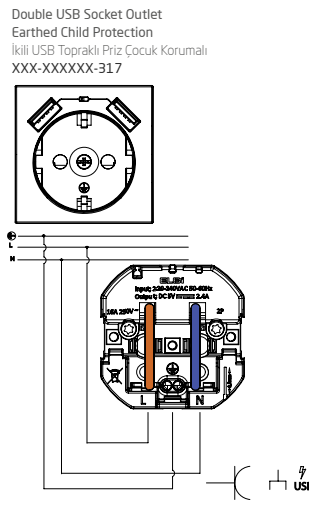

Double USB Socket Outlet
Earthed Child Protection
İkili USB Topraklı Priz Çocuk Korumalı
XXX-XXXXXX-317

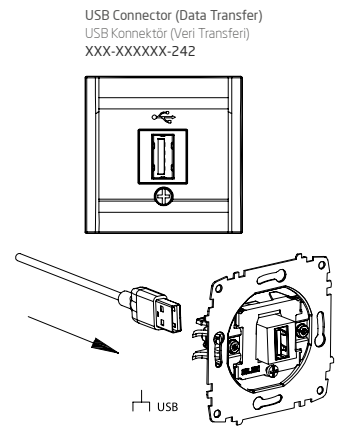

USB Connector (Data Transfer)
USB Konektör (Veri Transferi)
XXX-XXXXXX-242

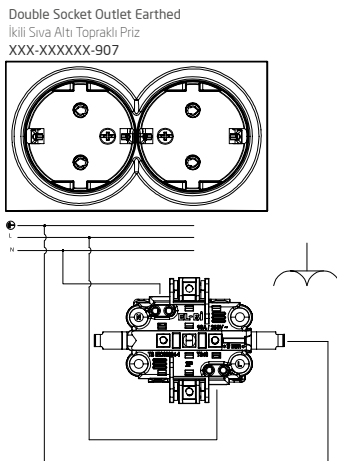

Double Socket Outlet Earthed
İkili Sıva Altı Topraklı Priz
XXX-XXXXXX-907

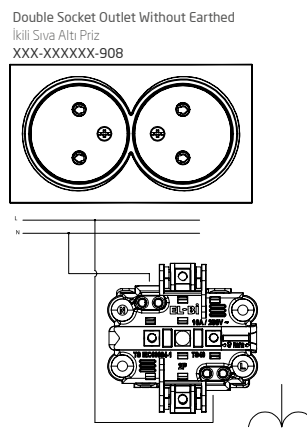

Double Socket Outlet Without Earthed
İkili Sıva Altı Priz
XXX-XXXXXX-908

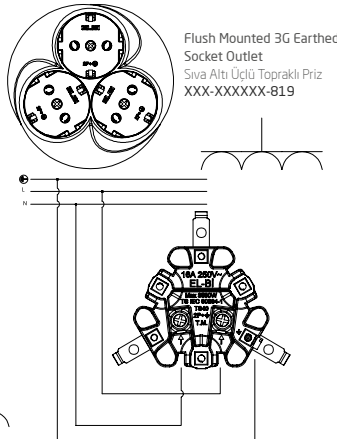

Flush Mounted 3G Earthed
Socket Outlet
Sıva Altı Üçlü Topraklı Priz
XXX-XXXXXX-819

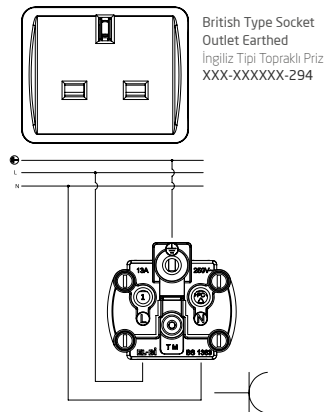

British Type Socket
Outlet Earthed
İngiliz Tipi Topraklı Priz
XXX-XXXXXX-294



Packing Information ***Ambalaj Bilgileri***

zena

Mechanism + Cover / Mekanizma + Kapak

Switch Mechanisms / Anahtar Mekanizmalar

Product Code Ürün Kodu	Product Name Ürün Adı	Units per box Kutudaki Adet	Units per package Koliadaki Adet
609-01XX00-200	1Gang 1Way Switch / Anahtar	12	120
609-01XX00-202	2Gang 1Way Switch / Komütatör	12	120
609-01XX00-204	Control Switch Door / Kapı Otomatiği Anahtarı	12	120
609-01XX00-205	Control Switch Light / Light Anahtarı	12	120
609-01XX00-207	Control Switch Bell / Zil Anahtarı	12	120
609-01XX00-209	1Gang 2Way Switch / Veavien	12	120
609-01XX00-211	2Gang 2Way Switch / Komütatör Veavien	12	120
609-01XX00-214	1Gang 2Way Switch Intermediate / Ara Veavien (Permütatör)	12	120
609-01XX00-216	Blind Switch / Jaluzi Kumanda Anahtarı (Çift Düğmeli)	12	120
609-01XX00-254	3Gang 1Way Switch / Üçlü Anahtar	12	120
609-01XX00-257	2Gang 1Way Control Switch Light / Komütatör Light	12	120
609-01XX00-261	Music Volume Control Switch / İkili Müzik Yayın Anahtarı (Stereo)	12	72
609-01XX00-269	Double Pole Switch / İki Kutuplu Anahtar	12	120
609-01XX00-279	3Gang 1Way Hvac Switch / 3'lü Klima Anahtarı	12	120
609-01XX00-281	Veavien + Light Switch / Veavien + Light Anahtar	12	120
609-01XX00-297	Blind Control Switch (3 Position) / Jaluzi Kumanda Anahtarı (Tek Düğmeli - 3 Konumlu)	12	120

Illuminated Switch Mechanisms / Işıklı Anahtar Mekanizmalar

609-01XX00-201	1Gang 1Way Switch Illuminated / Işıklı Anahtar	12	120
609-01XX00-203	2Gang 1Way Switch Illuminated / Işıklı Komütatör	12	120
609-01XX00-206	Control Switch Illuminated Light / Işıklı Light Anahtarı	12	120
609-01XX00-208	12V Illuminated Labelled Control Switch Bell / Işıklı İsimli Zil Anahtarı 12V	12	120
609-01XX00-210	1Gang 2Way Switch Illuminated / Işıklı Veavien	12	120
609-01XX00-236	Double Pole Switch Illuminated / Işıklı İki Kutuplu Anahtar	12	120

Sockets / Prizler

609-01XX00-215	Socket Outlet Without Earthed / Priz	12	120
609-01XX00-217	Socket Outlet Earthed / Topraklı Priz	12	120
609-01XX00-218	Socket Outlet Earthed With Hinged Lid / Kapaklı Topraklı Priz	10	100
609-01XX00-243	Socket Outlet Earthed Child Protection / Çocuk Korumalı Topraklı Priz	12	120
609-01XX00-219	Socket Outlet Earthed Child Protection With Hinged Lid / Çocuk Korumalı Kapaklı Topraklı Priz	10	100
609-01XX00-268	UPS Socket Outlet With Earthed Pin / UPS Priz	12	120
609-012600-268	Red UPS Socket Outlet Earthed Pin / UPS Priz (Kırmızı)	12	120
609-01XX00-263	Child Protection UPS Socket Outlet Earthed Pin / Çocuk Korumalı UPS Priz	12	120
609-012600-263	Red Child Protection UPS Socket Outlet Earthed Pin / Çocuk Korumalı UPS Priz (Kırmızı)	12	120
609-01XX00-143	Double USB Charger 5V 2,1A / USB Şarj Prizi 5V 2,1A Çiftli	6	36
609-01XX00-334	Double USB (Type C+A) Socket Outlet Earthed Child Protection / Çocuk Korumalı İkili USB (Type C+A) 2,4A Topraklı Priz	12	72
609-01XX00-317	Double USB Socket Outlet Earthed Child Protection / Çocuk Korumalı İkili USB Topraklı Priz	12	72
609-01XX00-335	Double USB Charging Socket (Type C+A) / USB Şarj Prizi (Type C+A) 2,4A Çiftli	6	36
500-01XX00-907	Double Socket Outlet Earthed / 2'li Sıva Altı Topraklı Priz	10	60
500-01XX00-908	Double Socket Outlet Without Earthed / 2'li Sıva Altı Priz	10	60
500-00XX00-819	Flush Mounted 3G Earthed Socket Outlet / Sıva Altı Üçlü Topraklı Priz	10	60

TV + SAT Products / TV + SAT Ürünleri

609-01XX00-246	TV Socket Outlet End Of Line / TV Prizi - Sonlu	12	120
609-01XX00-224	TV Socket Outlet Through Line / TV Priz - Geçişli	12	120
609-01XX00-180	SAT Socket Outlet F Type (Rg6 F Connector) / Uydu Prizi (Rg6 F Konnektörü)	12	120
609-01XX00-287	SAT Socket Outlet F Type Through Line / SAT (Uydu) Prizi Geçişli	12	120
609-01XX00-288	SAT Socket Outlet F Type End Of Line / SAT (Uydu) Prizi Sonlu	12	120
609-01XX00-289	TV + SAT Socket Outlet Through Line / TV + SAT Prizi - Geçişli	12	120
609-01XX00-290	TV + SAT Socket Outlet End Of Line / TV + SAT Prizi - Sonlu	12	120

* To select color of product please replace the XX with the color code: White 02, Cream 03, Black 30, Snow White 56, Latte (Anthracite) 40, M. Grey 10, Fume 11, Titanium 14, Ivory 25, Vantablack 48, Maple 27, New Cherry 28, White Oak 42, Mahogany 29, Matt White 62, Matt Cream 65, Mat Fume 67.

* Ürün renklerini belirtmek için ürün kodundaki XX yerine; 02 Beyaz, 03 Krem, 30 Siyah, 56 Karbeyaz, 40 Latte (Antrasit), 10 M. Gri, 11 Füme, 14 Titanyum, 25 Fildişi, 48 Vantablack, 28 Yeni Kiraz, 42 Beyaz Meşe, 29 Maun, 27 Akçağaç, 62 Mat Beyaz, 65 Mat Krem, 67 Mat Füme gelecek şekilde sipariş verilmelidir.

zena

Mechanism + Cover / Mekanizma + Kapak

Communication Products / İletişim Ürünleri

Product Code Ürün Kodu	Product Name Ürün Adı	Units per box Kutudaki Adet	Units per package Kolideki Adet
609-01XX00-221	Numeris Telephone Socket Outlet (RJ11 CAT3) / Nümeris Prizi (RJ11 CAT3)	12	120
609-01XX00-222	Double Numeris Telephone Socket Outlet (2 x RJ11 CAT3) / İkili Nümeris Prizi (2 x RJ11 CAT3)	12	120
609-01XX00-247	Data Socket Outlet (RJ45 CAT6) / Data Prizi (RJ45 CAT6)	12	120
609-01XX00-249	Data+Numeris Telephone Socket Outlet (RJ45 CAT6 + RJ11 CAT3) / Data Prizi+Nümeris Priz (RJ45 CAT6 + RJ11 CAT3)	12	120
609-01XX00-248	Double Data Socket Outlet (2 x RJ45 CAT6) / İkili Data Prizi (2 x RJ45 CAT6)	12	120
609-01XX00-241	Music Hi-Fi Socket Outlet 2 Gang / İkili Müzik Yayın Prizi	12	120
609-01XX00-284	HDMI Socket / HDMI Prizi	12	120
609-01XX00-336	Double HDMI Socket / İkili HDMI Prizi	12	120
609-01XX00-173	VGA Socket / VGA Prizi	12	120
609-01XX00-242	USB Connector (Data Transfer) / USB Konnektör (Veri Transferi)	12	120
609-01XX00-300	Fiber Optic Data Socket / Fiber Optik Sonlanmalı Data Prizi	12	120
609-01XX00-304	Double Fiber Optic Data Socket / İkili Fiber Optik Sonlanmalı Data Prizi	12	120
609-01XX00-337	Double USB Charging HDMI Socket / İkili USB Şarj HDMI Priz	12	120

Dimmers / Dimmerler

609-01XX00-112	Dimmer (1000W)	12	72
609-01XX00-144	Dimmer 500W CE	12	72
609-01XX00-316	1-10V Dimmer	12	72
609-01XX00-308	5-60W RC Led Dimmer	12	72
609-01XX00-310	5-300W RC Led Dimmer	12	72

Complementary Products / Tamamlayıcı Ürünler

609-01XX00-299	Blind Cover / Kör Kapak	12	120
609-01XX00-298	Cable Outlet Cover / Kablo Çıkış Kapağı	12	120
500-01XX00-253	Surface Mounting Box / Sıva Üstü Kasa	12	72
609-01XX00-282	Numeris Socket Without Jack / Nümeris Prizi Jaksız	12	120
609-01XX00-296	Data Socket Without Jack / Data Prizi Jaksız	12	120
609-01XX00-260	Data + Numeris Telephone Socket Outlet Without Jack / Data Prizi + Nümeris Priz Jaksız	12	120
609-01XX00-172	VGA Socket (Without Jack) / VGA Prizi (Konnektörsüz)	12	120

Energy Saver / Enerji Saver

609-01XX00-266	Mechanical Energy Saver / Mekanik Enerji Saver	12	72
609-01XX00-158	RFID Energy Saver / RFID Enerji Saver (VRV Kontrollü)	12	72
608-000000-158	RFID PVC Energy Saver / RFID PVC Enerji Saver Kartı (Logosuz)	10	60
609-01XX00-318	RF Energy Saver / RF Enerji Saver	12	72

Relays / Röleler

666-000216-132	RF 2 X 16A Power Control Unit / RF 2 X 16A Güç Kontrol Ünitesi	1	6
666-000216-127	RFID 2 X 16A Power Control Unit / RFID 2 X 16A Güç Kontrol Ünitesi	1	6
666-000316-127	RFID 3 X 16A Power Control Unit / RFID 3 X 16A Güç Kontrol Ünitesi	1	6

Eco Pack Frames / Eko Paket Çerçeveler

608-81XX00-271	Single Eco Pack Frame / Tekli Eko Paket Çerçeve		720
500-81XX00-226	2 Gang Eco Pack Frame / İkili Eko Paket Çerçeve		550
500-81XX00-227	3 Gang Eco Pack Frame / Üçlü Eko Paket Çerçeve		400
500-81XX00-228	4 Gang Eco Pack Frame / Dörtlü Eko Paket Çerçeve		300
500-81XX00-250	5 Gang Eco Pack Frame / Beşli Eko Paket Çerçeve		250
500-81XX00-252	6 Gang Eco Pack Frame / Altılı Eko Paket Çerçeve		200

Frames / Çerçeveler

608-01XX00-271	Single Frame / Tekli Çerçeve	24	240
500-01XX00-226	2 Gang Frame / İkili Çerçeve	12	120
500-01XX00-227	3 Gang Frame / Üçlü Çerçeve	12	120
500-01XX00-228	4 Gang Frame / Dörtlü Çerçeve	12	72
500-01XX00-250	5 Gang Frame / Beşli Çerçeve	12	72
500-01XX00-252	6 Gang Frame / Altılı Çerçeve	12	72

* To select color of product please replace the **XX** with the color code: White **02**, Cream **03**, Black **30**, Snow White **56**, Latte (Anthracite) **40**, M. Grey **10**, Fume **11**, Titanium **14**, Ivory **25**, Vantablack **48**, Maple **27**, New Cherry **28**, White Oak **42**, Mahogany **29**, Matt White **62**, Matt Cream **65**, Mat Fume **67**.

* Ürün renklerini belirtmek için ürün kodundaki **XX** yerine; **02** Beyaz, **03** Krem, **30** Siyah, **56** Karbeyaz, **40** Latte (Antrasit), **10** M. Gri, **11** Füme, **14** Titanyum, **25** Fildişi, **48** Vantablack, **28** Yeni Kiraz, **42** Beyaz Meşe, **29** Maun, **27** Akçağaç, **62** Mat Beyaz, **65** Mat Krem, **67** Mat Füme gelecek şekilde sipariş verilmelidir.

vega

Mechanism + Cover / Mekanizma + Kapak

Switch Mechanisms / Anahtar Mekanizmalar

Product Code Ürün Kodu	Product Name Ürün Adı	Units per box Kutudaki Adet	Units per package Kolidaki Adet
609-01XX00-200	1Gang 1Way Switch / Anahtar	12	120
609-01XX00-202	2Gang 1Way Switch / Komütatör	12	120
609-01XX00-204	Control Switch Door / Kapı Otomatiği Anahtarı	12	120
609-01XX00-205	Control Switch Light / Light Anahtarı	12	120
609-01XX00-207	Control Switch Bell / Zil Anahtarı	12	120
609-01XX00-209	1Gang 2Way Switch / Veavien	12	120
609-01XX00-211	2Gang 2Way Switch / Komütatör Veavien	12	120
609-01XX00-214	1Gang 2Way Switch Intermediate / Ara Veavien (Permütatör)	12	120
609-01XX00-216	Blind Switch / Jaluzi Kumanda Anahtarı (Çift Düğmeli)	12	120
609-01XX00-254	3Gang 1Way Switch / Üçlü Anahtar	12	120
609-01XX00-257	2Gang 1Way Control Switch Light / Komütatör Light	12	120
609-01XX00-261	Music Volume Control Switch / İkili Müzik Yayın Anahtarı (Stereo)	12	72
609-01XX00-269	Double Pole Switch / İki Kutuplu Anahtar	12	120
609-01XX00-279	3Gang 1Way Hvac Switch / 3'lü Klima Anahtarı	12	120
609-01XX00-281	Veavien + Light Switch / Veavien + Light Anahtar	12	120
609-01XX00-297	Blind Control Switch (3 Position) / Jaluzi Kumanda Anahtarı (Tek Düğmeli - 3 Konumlu)	12	120

Illuminated Switch Mechanisms / Işıklı Anahtar Mekanizmalar

609-01XX00-201	1Gang 1Way Switch Illuminated / Işıklı Anahtar	12	120
609-01XX00-203	2Gang 1Way Switch Illuminated / Işıklı Komütatör	12	120
609-01XX00-206	Control Switch Illuminated Light / Işıklı Light Anahtarı	12	120
609-01XX00-208	12V Illuminated Labelled Control Switch Bell / Işıklı İsimli Zil Anahtarı 12V	12	120
609-01XX00-210	1Gang 2Way Switch Illuminated / Işıklı Veavien	12	120
609-01XX00-236	Double Pole Switch Illuminated / Işıklı İki Kutuplu Anahtar	12	120

Sockets / Prizler

609-01XX00-215	Socket Outlet Without Earthed / Priz	12	120
609-01XX00-217	Socket Outlet Earthed / Topraklı Priz	12	120
609-01XX00-218	Socket Outlet Earthed With Hinged Lid / Kapaklı Topraklı Priz	10	100
609-01XX00-243	Socket Outlet Earthed Child Protection / Çocuk Korumalı Topraklı Priz	12	120
609-01XX00-219	Socket Outlet Earthed Child Protection With Hinged Lid / Çocuk Korumalı Kapaklı Topraklı Priz	10	100
609-01XX00-268	UPS Socket Outlet With Earthed Pin / UPS Priz	12	120
609-012600-268	Red UPS Socket Outlet Earthed Pin / UPS Priz (Kırmızı)	12	120
609-01XX00-263	Child Protection UPS Socket Outlet Earthed Pin / Çocuk Korumalı UPS Priz	12	120
609-012600-263	Red Child Protection UPS Socket Outlet Earthed Pin / Çocuk Korumalı UPS Priz (Kırmızı)	12	120
609-01XX00-143	Double USB Charger 5V 2,1A / USB Şarj Prizi 5V 2,1A Çiftli	6	36
609-01XX00-334	Double USB (Type C+A) Socket Outlet Earthed Child Protection / Çocuk Korumalı İkili USB (Type C+A) 2,4A Topraklı Priz	12	72
609-01XX00-317	Double USB Socket Outlet Earthed Child Protection / Çocuk Korumalı İkili USB Topraklı Priz	12	72
609-01XX00-335	Double USB Charging Socket (Type C+A) / USB Şarj Prizi (Type C+A) 2,4A Çiftli	6	36
510-01XX30-907	Double Socket Outlet Earthed / 2'li Sıva Altı Topraklı Priz	10	60
510-01XX30-908	Double Socket Outlet Without Earthed / 2'li Sıva Altı Priz	10	60
500-00XX00-819	Flush Mounted 3G Earthed Socket Outlet / Sıva Altı Üçlü Topraklı Priz	10	60

TV + SAT Products / TV + SAT Ürünleri

609-01XX00-246	TV Socket Outlet End Of Line / TV Prizi - Sonlu	12	120
609-01XX00-224	TV Socket Outlet Through Line / TV Priz - Geçişli	12	120
609-01XX00-180	SAT Socket Outlet F Type (Rg6 F Connector) / Uydu Prizi (Rg6 F Konnektörlü)	12	120
609-01XX00-287	SAT Socket Outlet F Type Through Line / SAT (Uydu) Prizi Geçişli	12	120
609-01XX00-288	SAT Socket Outlet F Type End Of Line / SAT (Uydu) Prizi Sonlu	12	120
609-01XX00-289	TV + SAT Socket Outlet Through Line / TV + SAT Prizi - Geçişli	12	120
609-01XX00-290	TV + SAT Socket Outlet End Of Line / TV + SAT Prizi - Sonlu	12	120

* To select color of product please replace the **XX** with the color code: White **02**, Cream **03**, Black **30**, Snow White **56**, Latte (Anthracite) **40**, M. Grey **10**, Fume **11**, Titanium **14**, Ivory **25**, Vantablack **48**, Maple **27**, New Cherry **28**, White Oak **42**, Mahogany **29**, Matt White **62**, Matt Cream **65**, Mat Fume **67**.

* Ürün renklerini belirtmek için ürün kodundaki **XX** yerine; **02** Beyaz, **03** Krem, **30** Siyah, **56** Karbeyaz, **40** Latte (Antrasit), **10** M. Gri, **11** Füme, **14** Titanyum, **25** Fildişi, **48** Vantablack, **28** Yeni Kiraz, **42** Beyaz Meşe, **29** Maun, **27** Akçağaç, **62** Mat Beyaz, **65** Mat Krem, **67** Mat Füme gelecek şekilde sipariş verilmelidir.

vega

Mechanism + Cover / Mekanizma + Kapak

Communication Products / İletişim Ürünleri

Product Code Ürün Kodu	Product Name Ürün Adı	Units per box Kutudaki Adet	Units per package Koliadaki Adet
609-01XX00-221	Numeris Telephone Socket Outlet (RJ11 CAT3) / Nümeris Prizi (RJ11 CAT3)	12	120
609-01XX00-222	Double Numeris Telephone Socket Outlet (2 x RJ11 CAT3) / İkili Nümeris Prizi (2 x RJ11 CAT3)	12	120
609-01XX00-247	Data Socket Outlet (RJ45 CAT6) / Data Prizi (RJ45 CAT6)	12	120
609-01XX00-249	Data+Numeris Telephone Socket Outlet (RJ45 CAT6 + RJ11 CAT3) / Data Prizi+Nümeris Priz (RJ45 CAT6 + RJ11 CAT3)	12	120
609-01XX00-248	Double Data Socket Outlet (2 x RJ45 CAT6) / İkili Data Prizi (2 x RJ45 CAT6)	12	120
609-01XX00-241	Music Hi-Fi Socket Outlet 2 Gang / İkili Müzik Yayın Prizi	12	120
609-01XX00-284	HDMI Socket / HDMI Prizi	12	120
609-01XX00-336	Double HDMI Socket / İkili HDMI Prizi	12	120
609-01XX00-173	VGA Socket / VGA Prizi	12	120
609-01XX00-242	USB Connector (Data Transfer) / USB Konnektör (Veri Transferi)	12	120
609-01XX00-300	Fiber Optic Data Socket / Fiber Optik Sonlanmalı Data Prizi	12	120
609-01XX00-304	Double Fiber Optic Data Socket / İkili Fiber Optik Sonlanmalı Data Prizi	12	120
609-01XX00-337	Double USB Charging HDMI Socket / İkili USB Şarj HDMI Priz	12	120

Dimmers / Dimmerler

609-01XX00-112	Dimmer (1000W)	12	72
609-01XX00-144	Dimmer 500W CE	12	72
609-01XX00-316	1-10V Dimmer	12	72
609-01XX00-308	5-60W RC Led Dimmer	12	72
609-01XX00-310	5-300W RC Led Dimmer	12	72

Complementary Products / Tamamlayıcı Ürünler

609-01XX00-299	Blind Cover / Kör Kapak	12	120
609-01XX00-298	Cable Outlet Cover / Kablo Çıkış Kapağı	12	120
609-01XX00-282	Numeris Socket Without Jack / Nümeris Prizi Jaksız	12	120
609-01XX00-296	Data Socket Without Jack / Data Prizi Jaksız	12	120
609-01XX00-260	Data + Numeris Telephone Socket Outlet Without Jack / Data Prizi + Nümeris Priz Jaksız	12	120
609-01XX00-172	VGA Socket (Without Jack) / VGA Prizi (Konnektörsüz)	12	120

Energy Saver / Enerji Saver

609-01XX00-266	Mechanical Energy Saver / Mekanik Enerji Saver	12	72
609-01XX00-158	RFID Energy Saver / RFID Enerji Saver (VRV Kontrollü)	12	72
608-000000-158	RFID PVC Energy Saver / RFID PVC Enerji Saver Kartı (Logosuz)	10	60
609-01XX00-318	RF Energy Saver / RF Enerji Saver	12	72

Relays / Röleler

666-000216-132	RF 2 X 16A Power Control Unit / RF 2 X 16A Güç Kontrol Ünitesi	1	6
666-000216-127	RFID 2 X 16A Power Control Unit / RFID 2 X 16A Güç Kontrol Ünitesi	1	6
666-000316-127	RFID 3 X 16A Power Control Unit / RFID 3 X 16A Güç Kontrol Ünitesi	1	6

Eco Pack Frames / Eko Paket Çerçeveler

510-81XX00-271	Single Eco Pack Frame / Tekli Eko Paket Çerçeve		720
510-81XX00-226	2 Gang Eco Pack Frame / İkili Eko Paket Çerçeve		550
510-81XX00-227	3 Gang Eco Pack Frame / Üçlü Eko Paket Çerçeve		400
510-81XX00-228	4 Gang Eco Pack Frame / Dörtlü Eko Paket Çerçeve		300
510-81XX00-250	5 Gang Eco Pack Frame / Beşli Eko Paket Çerçeve		250
510-81XX00-252	6 Gang Eco Pack Frame / Altılı Eko Paket Çerçeve		200

Frames / Çerçeveler

510-01XX00-271	Single Frame / Tekli Çerçeve	24	240
510-01XX00-226	2 Gang Frame / İkili Çerçeve	12	120
510-01XX00-227	3 Gang Frame / Üçlü Çerçeve	12	120
510-01XX00-228	4 Gang Frame / Dörtlü Çerçeve	12	72
510-01XX00-250	5 Gang Frame / Beşli Çerçeve	12	72
510-01XX00-252	6 Gang Frame / Altılı Çerçeve	12	72

* To select color of product please replace the **XX** with the color code: White **02**, Cream **03**, Black **30**, Snow White **56**, Latte (Anthracite) **40**, M. Grey **10**, Fume **11**, Titanium **14**, Ivory **25**, Vantablack **48**, Maple **27**, New Cherry **28**, White Oak **42**, Mahogany **29**, Matt White **62**, Matt Cream **65**, Mat Fume **67**.

* Ürün renklerini belirtmek için ürün kodundaki **XX** yerine; **02** Beyaz, **03** Krem, **30** Siyah, **56** Karbeyaz, **40** Latte (Antrasit), **10** M. Gri, **11** Füme, **14** Titanyum, **25** Fildişi, **48** Vantablack, **28** Yeni Kiraz, **42** Beyaz Meşe, **29** Maun , **27** Akçağaç, **62** Mat Beyaz, **65** Mat Krem, **67** Mat Füme gelecek şekilde sipariş verilmelidir.

jazz

Mechanism + Cover / Mekanizma + Kapak

Switch Mechanisms / Anahtar Mekanizmalar

Product Code Ürün Kodu	Product Name Ürün Adı	Units per box Kutudaki Adet	Units per package Kolidaki Adet
607-01XX00-200	1Gang 1Way Switch / Anahtar	12	120
607-01XX00-202	2Gang 1Way Switch / Komütatör	12	120
607-01XX00-204	Control Switch Door / Kapı Otomatiği Anahtarı	12	120
607-01XX00-205	Control Switch Light / Light Anahtarı	12	120
607-01XX00-207	Control Switch Bell / Zil Anahtarı	12	120
607-01XX00-208	12V Illuminated Labelled Control Switch Bell / Işıklı İsimli Zil Anahtarı 12V	12	120
607-01XX00-209	1Gang 2Way Switch / Veavien	12	120
607-01XX00-211	2Gang 2Way Switch / Komütatör Veavien	12	120
607-01XX00-214	1Gang 2Way Switch Intermediate / Ara Veavien (Permütatör)	12	120
607-01XX00-216	Blind Switch / Jaluzi Kumanda Anahtarı (Çift Düğmeli)	12	120
607-01XX00-254	3Gang 1Way Switch / Üçlü Anahtar	12	120
607-01XX00-269	Double Pole Switch / İki Kutuplu Anahtar	12	120
607-01XX00-281	Veavien + Light Switch / Veavien + Light Anahtar	12	120
607-00XX00-261	Music Volume Control Switch / İkili Müzik Yayın Anahtarı (Stereo)	12	120
607-01XX00-257	2Gang 1Way Control Switch Light / Komütatör Light	12	120

Illuminated Switch Mechanisms / Işıklı Anahtar Mekanizmalar

607-01XX00-201	1Gang 1Way Switch Illuminated / Işıklı Anahtar	12	120
607-01XX00-203	2Gang 1Way Switch Illuminated / Işıklı Komütatör	12	120
607-01XX00-206	Control Switch Illuminated Light / Işıklı Light Anahtarı	12	120
607-01XX00-210	1Gang 2Way Switch Illuminated / Işıklı Veavien	12	120
607-01XX00-236	Double Pole Switch Illuminated / Işıklı İki Kutuplu Anahtar	12	120

Sockets / Prizler

607-01XX00-215	Socket Outlet Without Earthed / Priz	12	120
607-01XX00-217	Socket Outlet Earthed / Topraklı Priz	12	120
607-01XX00-218	Socket Outlet Earthed With Hinged Lid / Kapaklı Topraklı Priz	10	100
607-01XX00-243	Socket Outlet Earthed Child Protection / Çocuk Korumalı Topraklı Priz	12	120
607-01XX00-219	Socket Outlet Earthed Child Protection With Hinged Lid / Çocuk Korumalı Kapaklı Topraklı Priz	12	120
607-01XX00-268	UPS Socket Outlet With Earthed Pin / UPS Priz	12	120
607-01XX00-263	Child Protection UPS Socket Outlet Earthed Pin / Çocuk Korumalı UPS Priz	10	60
607-00XX00-241	Music Hi-Fi Socket Outlet 2 Gang / 2'li Müzik Yayın Prizi	10	60
607-01XX00-242	USB Connector Socket / USB Konnektör Priz	12	120
508-01XX00-917	Child Protection Double Socket Outlet Earthed / Çocuk Korumalı 2'li SivaAltı Topraklı Priz	12	120
508-01XX00-918	Child Protection Double Socket Outlet Without Earthed / Çocuk Korumalı 2'li SivaAltı Normal Priz	10	100

TV + SAT Products / TV + SAT Ürünleri

607-00XX00-180	SAT Socket Outlet F Type (Rg6 F Connector) / Uydu Prizi (Rg6 F Konnektörlü)	12	120
607-00XX00-287	SAT Socket Outlet F Type Through Line / SAT (Uydu) Prizi Geçişli	12	120
607-00XX00-288	SAT Socket Outlet F Type End Of Line / SAT (Uydu) Prizi Sonlu	12	120
607-00XX00-289	TV + SAT Socket Outlet Through Line / TV + SAT Prizi - Geçişli	12	120
607-00XX00-290	TV + SAT Socket Outlet End Of Line / TV + SAT Prizi - Sonlu	12	120

Communication Products / İletişim Ürünleri

607-00XX00-221	Numeris Telephone Socket Outlet (RJ11 CAT3) / Nümeris Prizi (RJ11 CAT3)	12	120
607-00XX00-222	Double Numeris Telephone Socket Outlet (2 x RJ11 CAT3) / İkili Nümeris Prizi (2 x RJ11 CAT3)	12	120
607-00XX00-247	Data Socket Outlet (RJ45 CAT6) / Data Prizi (RJ45 CAT6)	12	120
607-00XX00-248	Double Data Socket Outlet (2 x RJ45 CAT6) / İkili Data Prizi (2 x RJ45 CAT6)	12	120
607-00XX00-249	Data+Numeris Telephone Socket Outlet (RJ45 CAT6 + RJ11 CAT3) / Data Prizi+Nümeris Priz (RJ45 CAT6 + RJ11 CAT3)	12	120
607-01XX00-300	Fiber Optic Data Socket / Fiber Optik Sonlanmalı Data Prizi	12	120
607-01XX00-304	Double Fiber Optic Data Socket / İkili Fiber Optik Sonlanmalı Data Prizi	12	120
607-01XX00-284	HDMI Socket / HDMI Prizi	12	120
607-01XX00-336	Double HDMI Socket / İkili HDMI Prizi	12	120
607-01XX00-337	Double USB Charging HDMI Socket / İkili USB Şarj HDMI Priz	12	120

* To select color of product please replace the **XX** with the color code: White **02**, Cream **03**, Black **30**, Snow White **56**, Latte (Anthracite) **40**, M. Grey **10**, Fume **11**, Titanium **14**, Ivory **25**, Vantablack **48**, Maple **27**, New Cherry **28**, White Oak **42**, Mahogany **29**, Matt White **62**, Matt Cream **65**, Mat Fume **67**.

* Ürün renklerini belirtmek için ürün kodundaki **XX** yerine; **02** Beyaz, **03** Krem, **30** Siyah, **56** Karbeyaz, **40** Latte (Antrasit), **10** M. Gri, **11** Füme, **14** Titanyum, **25** Fildişi, **48** Vantablack, **28** Yeni Kiraz, **42** Beyaz Meşe, **29** Maun, **27** Akçağaç, **62** Mat Beyaz, **65** Mat Krem, **67** Mat Füme gelecek şekilde sipariş verilmelidir.

Dimmers / Dimmerler

Product Code Ürün Kodu	Product Name Ürün Adı	Units per box Kutudaki Adet	Units per package Koliadaki Adet
607-00XX00-112	Dimmer 1000W	12	72
607-01XX00-192	Işıklı Dimmer 1000W	12	120
607-01XX00-308	RC LED Dimmer 5-60W	12	120
607-01XX00-310	RC LED Dimmer 5-300W	12	72
607-01XX00-316	1-10V Dimmer	12	72

Complementary Products / Tamamlayıcı Ürünler

607-00XX00-260	Data + Numeris Telephone Socket Outlet Without Jack / Data Prizi + Nümeris Priz Jaksız	12	120
607-00XX00-296	Data Socket Without Jack / Data Prizi Jaksız	12	72
607-00XX00-298	Cable Outlet Cover / Kablo Çıkış Kapağı	12	120

Energy Saver / Enerji Saver

607-01XX00-158	RFID Energy Saver / RFID Enerji Saver	12	72
607-01XX00-318	RF Energy Saver / RF Enerji Saver	12	72
608-000000-158	RFID PVC Energy Saver / RFID PVC Enerji Saver Kartı	12	72

Relays / Röleler

666-000216-132	RF 2 X 16A Power Control Unit / RF 2 X 16A Güç Kontrol Ünitesi	1	-
666-000216-127	RFID 2 X 16A Power Control Unit / RFID 2 X 16A Güç Kontrol Ünitesi	12	72
666-000316-127	RFID 3 X 16A Power Control Unit / RFID 3 X 16A Güç Kontrol Ünitesi	12	72

Eco Pack Frames / Eko Paket Çerçeveler

508-81XX00-271	Single Eco Pack Frame / Tekli Eko Paket Çerçeve		720
508-81XX00-226	2 Gang Eco Pack Frame / İkili Eko Paket Çerçeve		550
508-81XX00-227	3 Gang Eco Pack Frame / Üçlü Eko Paket Çerçeve		400
508-81XX00-228	4 Gang Eco Pack Frame / Dörtlü Eko Paket Çerçeve		300
508-81XX00-250	5 Gang Eco Pack Frame / Beşli Eko Paket Çerçeve		250
508-81XX00-252	6 Gang Eco Pack Frame / Altılı Eko Paket Çerçeve		200

Frames / Çerçeveler

508-00XX00-271	Single Frame / Tekli Çerçeve	24	240
508-00XX00-226	2 Gang Frame / İkili Çerçeve	12	120
508-00XX00-227	3 Gang Frame / Üçlü Çerçeve	12	120
508-00XX00-228	4 Gang Frame / Dörtlü Çerçeve	12	72
508-00XX00-250	5 Gang Frame / Beşli Çerçeve	12	72
508-00XX00-252	6 Gang Frame / Altılı Çerçeve	12	72

* To select color of product please replace the XX with the color code: White 02, Cream 03, Black 30, Snow White 56, Latte (Anthracite) 40, M. Grey 10, Fume 11, Titanium 14, Ivory 25, Vantablack 48, Maple 27, New Cherry 28, White Oak 42, Mahogany 29, Matt White 62, Matt Cream 65, Mat Fume 67.

* Ürün renklerini belirtmek için ürün kodundaki XX yerine; 02 Beyaz, 03 Krem, 30 Siyah, 56 Karbeyaz, 40 Latte (Antrasit), 10 M. Gri, 11 Füme, 14 Titanyum, 25 Fildişi, 48 Vantablack, 28 Yeni Kiraz, 42 Beyaz Meşe, 29 Maun, 27 Akçaağaç, 62 Mat Beyaz, 65 Mat Krem, 67 Mat Füme gelecek şekilde sipariş verilmelidir.

turn on the life



Note:

ELBİ reserves the right to make technical changes or change the content of this document without prior notice.

Mutually agreed specifications will be valid for purchase orders.

ELBİ will not take any responsibility for possible errors or lack of information in this document.

Copyright of this document and the related subject and the images used here reserves.

Without the written consent of ELBI, any kind of copying, use of third parties or benefiting from its contents - in whole or in part - is prohibited.

Our company is not responsible for typographic errors and color differences arising from the application of offset printing technique in product images.

Not:

ELBİ önceden haber vermeksizin teknik değişiklikler yapma veya bu dokümanın içeriğini değiştirme hakkını saklı tutmaktadır.

Satınalma siparişlerinde, üzerinde karşılıklı anlaşılmış özellikler geçerli olacaktır.

ELBİ, bu dokümandaki olası hatalar veya bilgi eksiklikleri için herhangi bir sorumluluk kabul etmeyecektir.

Bu doküman ve ilgili konu ile burada kullanılan resimlerin telif hakkını saklı tutmaktadır.

ELBİ'nin yazılı izni olmaksızın, her türlü kopyalama, üçüncü kişilerin kullanımı veya içeriğinden yararlanma - tümü ya da bir kısmı - yasaktır.

Tipografik hatalardan ve ürün görsellerinde ofset baskı tekniği uygulamasından kaynaklanan renk farklılaşmalarından firmamız sorumlu değildir.

© Copyright 2023 - 2024 ELBİ Tüm hakları saklıdır.



RoHS



ELBİ Uluslararası Elektrik Sanayi Tic. A.Ş.

Mehmet Akif Ersoy Mah.
Maltepe Cad.
No: 72 Taşoluk, Arnavutköy
İSTANBUL / TURKEY

Tel: +90 212 682 09 09

Export mail : export@el-bi.com

elbielectric.com

#ELBİelektrik

#elbielektrik

#ELBİelektrik