

ELBI
ELECTRIC

turn on the life

2024

CATALOG / KATALOG



EN-TUR

CONTENTS / İÇİNDEKİLER

modaviona	03-11
modavoice	12-15
modastila	16-19
moda	20-25
vox	26-33
zenaplatin	34-37
arya	38-41
aryabold	42-45
aryaefekt	46-47
aryanatural	48-49
aryasilverline	50-51
zena	52-63
vega	64-75
jazz	76-85
zirve	86-96
tuna	97-107
eva	108-111
alsu	112-115
myra	116-123
deniz	124-126
power control units / güç kontrol üniteleri	127-128
accessories / aksesuarlar	129-133

turn on the life

modaviona

Double Your Shine.

It is designed to add eye-catching sparkle to your spaces with Wooden, Glass, Aluminum and Marble Frame options. Its unlimited modular structure, where you can fit the functions you want, will bring your spaces out of narrow molds..

Işıltınızı Katlayın.

Ahşap, cam, alüminyum ve mermer çerçeve seçenekleriyle mekanlarınıza göz alıcı ışığı katmak için tasarlandı. Dilediğiniz fonksiyonları sığdırabileceğiniz sınırsız modüler yapısı, mekanlarınızı dar kalıplar içerisinde çıkaracak.



Frames / Çerçeveler

| Aluminium / Alüminyum

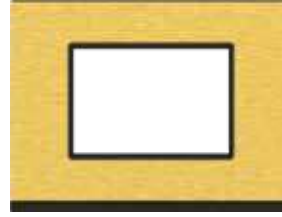
SILVER / GÜMÜŞ
611-10XX1Y-271BRONZE / BRONZ
611-11XX1Y-271GOLD / ALTIN
611-12XX1Y-271ONYX / ONİKS
611-13XX1Y-271

| Safe Glass / Cam

KHAKE
KESE KAĞIDI
611-59XX1Y-271MATT WHITE
MAT BEYAZ
611-51XX1Y-271MATT BLACK
MAT SİYAH
611-37XX1Y-271

| Wood / Ahşap

AMERICAN WALNUT
AMERİKAN CEVİZ
611-49XX1Y-271BAMBOO
BAMBU
611-50XX1Y-271

| Marble / Mermer

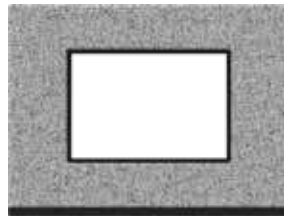
KUMİNİTY
611-46XX1Y-271GRİNİTY
611-47XX1Y-271

2 / 2 Module - 2 Modül
 3 / 3 Module - 3 Modül
 Y = 4 / 4 Module - 4 Modül
 7 / 7 Module - 7 Modül

* To select color of product please replace the XX with the color code: Metallic Grey 10, Fume 11, Titanium 14, Chrome 31, Vantablack 48, Black 30.

* Ürün renklerini belirtmek için ürün kodundaki XX yerine; 10 Metalik Gri, 11 Füme, 14 Titanyum, 31 Krom, 48 Vantablack, 30 Siyah gelecek şekilde sipariş verilmelidir.

Frames / Çerçeveler

Aluminium / Alüminyum

Silver | Gümüş

Product Code Ürün Kodu	Product Name Ürün Adı	Units per box Kutudaki Adet	Units per package Koliadaki Adet
611-10XX12-271	2M frame / 2M çerçeve	5	50
611-10XX13-271	3M frame / 3M çerçeve	5	30
611-10XX14-271	4M frame / 4M çerçeve	5	30
611-10XX17-271	7M frame / 7M çerçeve	5	30

Bronze | Bronz

Product Code Ürün Kodu	Product Name Ürün Adı	Units per box Kutudaki Adet	Units per package Koliadaki Adet
611-11XX12-271	2M frame / 2M çerçeve	5	50
611-11XX13-271	3M frame / 3M çerçeve	5	30
611-11XX14-271	4M frame / 4M çerçeve	5	30
611-11XX17-271	7M frame / 7M çerçeve	5	30

Gold | Altın

Product Code Ürün Kodu	Product Name Ürün Adı	Units per box Kutudaki Adet	Units per package Koliadaki Adet
611-12XX12-271	2M frame / 2M çerçeve	5	50
611-12XX13-271	3M frame / 3M çerçeve	5	30
611-12XX14-271	4M frame / 4M çerçeve	5	30
611-12XX17-271	7M frame / 7M çerçeve	5	30

Onyx | Oniks

Product Code Ürün Kodu	Product Name Ürün Adı	Units per box Kutudaki Adet	Units per package Koliadaki Adet
611-13XX12-271	2M frame / 2M çerçeve	5	50
611-13XX13-271	3M frame / 3M çerçeve	5	30
611-13XX14-271	4M frame / 4M çerçeve	5	30
611-13XX17-271	7M frame / 7M çerçeve	5	30

Wood / Ahşap

American Walnut | Amerikan Cevizi

Product Code Ürün Kodu	Product Name Ürün Adı	Units per box Kutudaki Adet	Units per package Koliadaki Adet
611-49XX12-271	2M frame / 2M çerçeve	5	50
611-49XX13-271	3M frame / 3M çerçeve	5	30
611-49XX14-271	4M frame / 4M çerçeve	5	30
611-49XX17-271	7M frame / 7M çerçeve	5	30

Bamboo | Bambu

Product Code Ürün Kodu	Product Name Ürün Adı	Units per box Kutudaki Adet	Units per package Koliadaki Adet
611-50XX12-271	2M frame / 2M çerçeve	5	50
611-50XX13-271	3M frame / 3M çerçeve	5	30
611-50XX14-271	4M frame / 4M çerçeve	5	30
611-50XX17-271	7M frame / 7M çerçeve	5	30

* To select color of product please replace the XX with the color code: Metallic Grey 10, Fume 11, Titanium 14, Chrome 31, Vantablack 48, Black 30.

* Ürün renklerini belirtmek için ürün kodundaki XX yerine; 10 Metalik Gri, 11 Füme, 14 Titanyum, 31 Krom, 48 Vantablack, 30 Siyah, gelecek şekilde sipariş verilmelidir.

Safe Glass / Cam

Matt White | Mat Beyaz

Product Code Ürün Kodu	Product Name Ürün Adı	Units per box Kutudaki Adet	Units per package Kolideki Adet
611-51XX12-271	2M frame / 2M çerçeve	5	50
611-51XX13-271	3M frame / 3M çerçeve	5	30
611-51XX14-271	4M frame / 4M çerçeve	5	30
611-51XX17-271	7M frame / 7M çerçeve	5	30

Matt Black | Mat Siyah

Product Code Ürün Kodu	Product Name Ürün Adı	Units per box Kutudaki Adet	Units per package Kolideki Adet
611-37XX12-271	2M frame / 2M çerçeve	5	50
611-37XX13-271	3M frame / 3M çerçeve	5	30
611-37XX14-271	4M frame / 4M çerçeve	5	30
611-37XX17-271	7M frame / 7M çerçeve	5	30

Khaki | Kese Kağıdı

Product Code Ürün Kodu	Product Name Ürün Adı	Units per box Kutudaki Adet	Units per package Kolideki Adet
611-59XX12-271	2M frame / 2M çerçeve	5	50
611-59XX13-271	3M frame / 3M çerçeve	5	30
611-59XX14-271	4M frame / 4M çerçeve	5	30
611-59XX17-271	7M frame / 7M çerçeve	5	30

Marble / Mermer

Kuminity

Product Code Ürün Kodu	Product Name Ürün Adı	Units per box Kutudaki Adet	Units per package Kolideki Adet
611-46XX12-271	2M frame / 2M çerçeve	5	50
611-46XX13-271	3M frame / 3M çerçeve	5	30
611-46XX14-271	4M frame / 4M çerçeve	5	30
611-46XX17-271	7M frame / 7M çerçeve	5	30

Grinity

Product Code Ürün Kodu	Product Name Ürün Adı	Units per box Kutudaki Adet	Units per package Kolideki Adet
611-47XX12-271	2M frame / 2M çerçeve	5	50
611-47XX13-271	3M frame / 3M çerçeve	5	30
611-47XX14-271	4M frame / 4M çerçeve	5	30
611-47XX17-271	7M frame / 7M çerçeve	5	30

* To select color of product please replace the XX with the color code: Metallic Grey 10, Fume 11, Titanium 14, Chrome 31, Vantablack 48, Black 30.

* Ürün renklerini belirtmek için ürün kodundaki XX yerine; 10 Metalik Gri, 11 Füme, 14 Titanyum, 31 Krom, 48 Vantablack, 30 Siyah, gelecek şekilde sipariş verilmelidir.

Frames / Çerçeveler

Silver / Gümüş



Silver
Vantablack 3M frame

Gümüş
Vantablack 3M çerçeve

611-104813-271



Silver
Metallic Grey 3M frame

Gümüş
Metalik Gri 3M çerçeve

611-101013-271



Silver
Fume 3M frame

Gümüş
Füme 3M çerçeve

611-101113-271

Bronze / Bronz



Bronze
Vantablack 3M frame

Bronz
Vantablack 3M çerçeve

611-114813-271



Bronze
Metallic Grey 3M frame

Bronz
Metalik Gri 3M çerçeve

611-111013-271



Bronze
Fume 3M frame

Bronz
Füme 3M çerçeve

611-111113-271

Gold / Altın

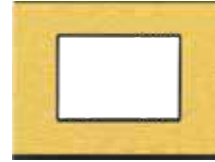

Gold
Vantablack 3M frame

Altın
Vantablack 3M çerçeve

611-124813-271

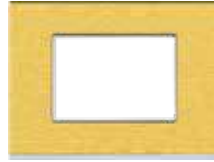

Gold
Metallic Grey 3M frame

Altın
Metalik Gri 3M çerçeve

611-121013-271

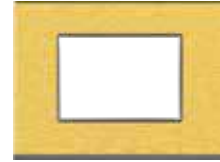

Gold
Fume 3M frame

Altın
Füme 3M çerçeve

611-121113-271

Onyx / Oniks



Onyx
Vantablack 3M frame

Oniks
Vantablack 3M çerçeve

611-134813-271

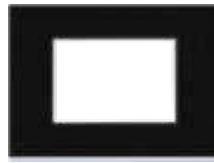

Onyx
Metallic Grey 3M frame

Oniks
Metalik Gri 3M çerçeve

611-131013-271



Onyx
Fume 3M frame

Oniks
Füme 3M çerçeve

611-131113-271

Frames / Çerçeveler



Titanium
Titanium
Silver
Titanium 3M frame
Gümüş
Titanium 3M çerçeve
611-101413-271



Chrome
Krom
Silver
Chrome 3M frame
Gümüş
Krom 3M çerçeve
611-103113-271



Bronze
Titanium 3M frame
Bronz
Titanium 3M çerçeve
611-111413-271



Bronze
Chrome 3M frame
Bronz
Krom 3M çerçeve
611-113113-271

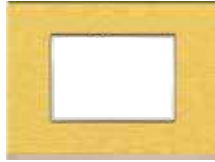

Gold
Titanium 3M frame
Altın
Titanium 3M çerçeve
611-121413-271



Gold
Chrome 3M frame
Altın
Krom 3M çerçeve
611-123113-271



Onyx
Titanium 3M frame
Oniks
Titanium 3M çerçeve
611-131413-271



Onyx
Chrome 3M frame
Oniks
Krom 3M çerçeve
611-133113-271

modaviona

Gang Frames / Çoklu Çerçeveler

Aluminium / Alüminyum

Product Code Ürün Kodu	Product Name Ürün Adı	Units per box Kutudaki Adet	Units per package Kolidaki Adet
611-10XX02-226	2 Gang Frame / 2'li Çerçeve	5	30
611-10XX02-227	3 Gang Frame / 3'lü Çerçeve	5	30
611-10XX02-228	4 Gang Frame / 4'lü Çerçeve	5	30

Bronze / Bronz

611-11XX02-226	2 Gang Frame / 2'li Çerçeve	5	30
611-11XX02-227	3 Gang Frame / 3'lü Çerçeve	5	30
611-11XX02-228	4 Gang Frame / 4'lü Çerçeve	5	30

Gold / Altın

611-12XX02-226	2 Gang Frame / 2'li Çerçeve	5	30
611-12XX02-227	3 Gang Frame / 3'lü Çerçeve	5	30
611-12XX02-228	4 Gang Frame / 4'lü Çerçeve	5	30

Onyx / Oniks

611-13XX02-226	2 Gang Frame / 2'li Çerçeve	5	30
611-13XX02-227	3 Gang Frame / 3'lü Çerçeve	5	30
611-13XX02-228	4 Gang Frame / 4'lü Çerçeve	5	30

Wood / Ahşap

Product Code Ürün Kodu	Product Name Ürün Adı	Units per box Kutudaki Adet	Units per package Kolidaki Adet
611-49XX02-226	2 Gang Frame / 2'li Çerçeve	5	30
611-49XX02-227	3 Gang Frame / 3'lü Çerçeve	5	30
611-49XX02-228	4 Gang Frame / 4'lü Çerçeve	5	30

Bamboo / Bambu

611-50XX02-226	2 Gang Frame / 2'li Çerçeve	5	30
611-50XX02-227	3 Gang Frame / 3'lü Çerçeve	5	30
611-50XX02-228	4 Gang Frame / 4'lü Çerçeve	5	30

Safe Glass / Cam

Product Code Ürün Kodu	Product Name Ürün Adı	Units per box Kutudaki Adet	Units per package Kolidaki Adet
611-51XX02-226	2 Gang Frame / 2'li Çerçeve	5	30
611-51XX02-227	3 Gang Frame / 3'lü Çerçeve	5	30
611-51XX02-228	4 Gang Frame / 4'lü Çerçeve	5	30

Khaki / Kese Kağıdı

611-59XX02-226	2 Gang Frame / 2'li Çerçeve	5	30
611-59XX02-227	3 Gang Frame / 3'lü Çerçeve	5	30
611-59XX02-228	4 Gang Frame / 4'lü Çerçeve	5	30

Matt Black / Mat Siyah

611-37XX02-226	2 Gang Frame / 2'li Çerçeve	5	30
611-37XX02-227	3 Gang Frame / 3'lü Çerçeve	5	30
611-37XX02-228	4 Gang Frame / 4'lü Çerçeve	5	30

Marble / Mermer

Product Code Ürün Kodu	Product Name Ürün Adı	Units per box Kutudaki Adet	Units per package Kolidaki Adet
611-46XX02-271	2 Gang Frame / 2'li Çerçeve	5	30
611-46XX02-271	3 Gang Frame / 3'lü Çerçeve	5	30
611-46XX02-271	4 Gang Frame / 4'lü Çerçeve	5	30

Grinity

611-47XX02-271	2 Gang Frame / 2'li Çerçeve	5	30
611-47XX02-271	3 Gang Frame / 3'lü Çerçeve	5	30
611-47XX02-271	4 Gang Frame / 4'lü Çerçeve	5	30

* It could be differences in the patterns of wooden products. * Ahşap ürünlerin desenlerinde farklılıklar olabilir.

* To select color of product please replace the XX with the color code: Metallic Grey 10, Fume 11, Titanium 14, Chrome 31, Vantablack 48.

* Ürün renklerini belirtmek için ürün kodundaki XX yerine; 10 Metalik Gri, 11 Füme, 14 Titanyum, 31 Krom, 48 Vantablack gelecek şekilde sipariş verilmelidir.

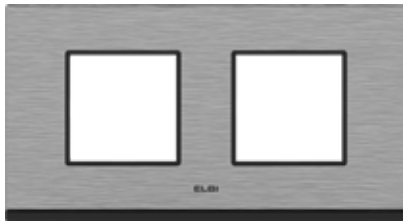

2 Gang Frame Horizontal
2'li Yatay Çerçeve
611-YYXX02-226

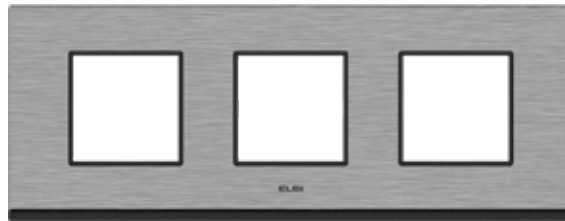

3 Gang Frame Horizontal
3'lü Yatay Çerçeve
611-YYXX02-227

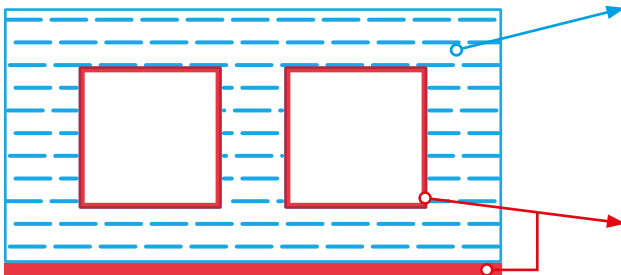

Product Color / Ürün Rengi

* To select color of product please replace the YY with the color code: 10 Silver, 11 Bronze, 12 Gold, 13 Onyx, 49 American Walnut, 50 Bamboo, 51 Matt White, 37 Matt Black, 59 Khaki, 46 Kuminity 47.

* Ürün renklerini belirtmek için ürün kodundaki YY yerine; 10 Gümüş, 11 Bronz, 12 Altın, 13 Oniks, 49 Amerikan Ceviz, 50 Bambu, 51 Mat Beyaz, 37 Mat Siyah, 59 Kese Kağıdı, 46 Kuminity, 47 Grinity gelecek şekilde sipariş verilmelidir.

Product Color / Ürün Rengi

* To select color of product please replace the XX with the color code: Metallic Grey 10, Fume 11, Titanium 14, Chrome 31, Vantablack 48.

* Ürün renklerini belirtmek için ürün kodundaki XX yerine; 10 Metalik Gri, 11 Füme, 31 Krom, 14 Titanyum, 48 Vantablack gelecek şekilde sipariş verilmelidir.

Montage Schema / Montaj Şeması

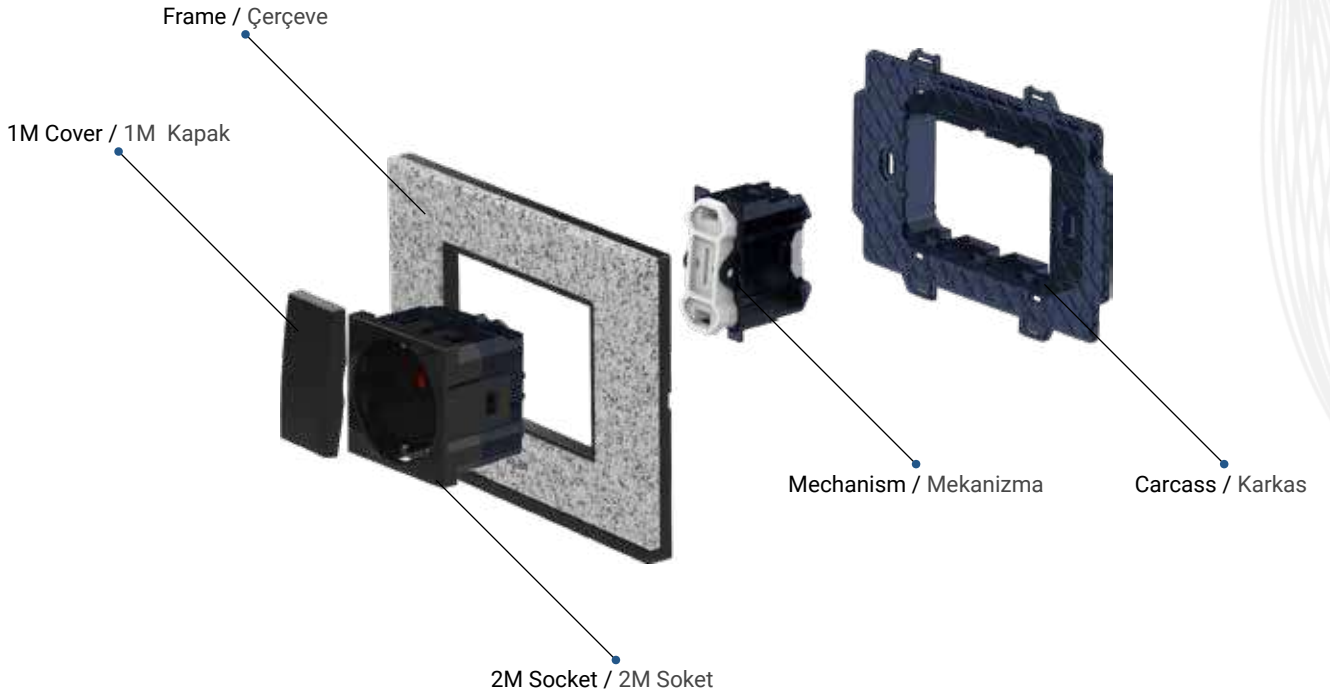

Frame Size / Çerçeve Ebatları

2M

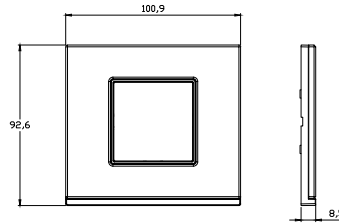

3M

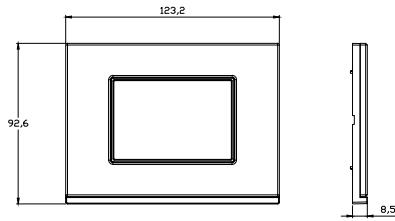

4M

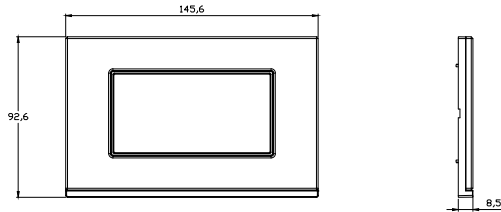

7M

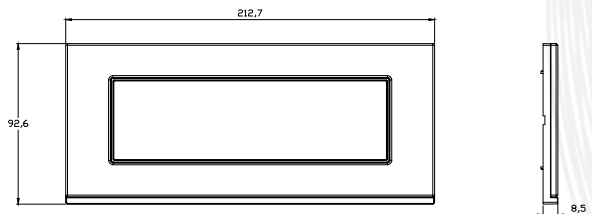

turn on the life

voice

Minimalist Aesthetics, Maximum Functionality.

Voice, can be personalized thanks to its modular design and different color options. Add or remove additional modules as you need. These sockets offer the freedom to shape energy management as you wish.

Minimalist stetik, Maksimum İşlevsellik.

Voice, modüler tasarımı ve farklı renk seçenekleri ile sayesinde kişiselleştirilebilir. İhtiyacınıza göre ek modüller ekleyin veya çıkarın. Bu prizler, enerji yönetimini sizin istediğiniz gibi şekillendirme özgürlüğü sunar.



ELBI
ELECTRIC

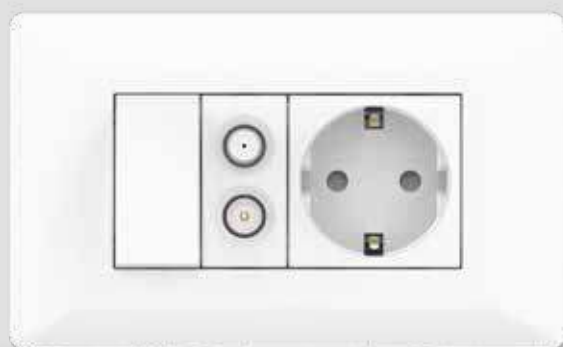
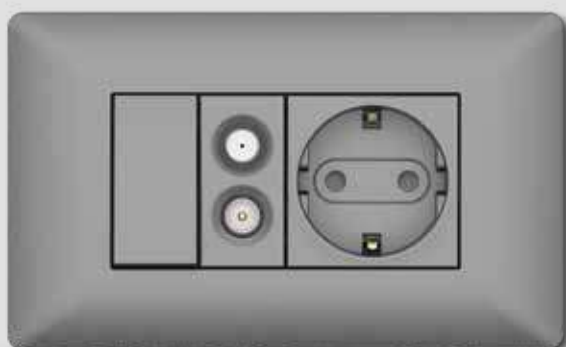

Frames / Çerçeveler

voice | natural

Product Code Ürün kodu	Product Name Ürün adı	Units Per Box Kutudaki adet	Units Per Package Koliadaki adet
611-020212-271	2M frame / 2M çerçeve	10	100
611-020213-271	3M frame / 3M çerçeve	10	100
611-020211-271	3/1M frame / 3/1M çerçeve	10	100
611-020212-226	3/2M frame / 3/2M çerçeve	10	100
611-020214-271	4M frame / 4M çerçeve	10	100
611-020217-271	7M frame / 7M çerçeve	10	100

White / Beyaz
02

voice | silverline

Product Code Ürün kodu	Product Name Ürün adı	Units Per Box Kutudaki adet	Units Per Package Koliadaki adet
611-02XX12-271	2M frame / 2M çerçeve	10	100
611-02XX13-271	3M frame / 3M çerçeve	10	100
611-02XX11-271	3/1M frame / 3/1M çerçeve	10	100
611-02XX12-226	3/2M frame / 3/2M çerçeve	10	100
611-02XX14-271	4M frame / 4M çerçeve	10	100
611-02XX17-271	7M frame / 7M çerçeve	10	100

* To select color of product please replace the XX with the color code: Metallic Grey 10, Fume 11, Vantablack 48.

* Ürün renklerini belirtmek için ürün kodundaki XX yerine; 10 Metallik Gri, 11 Füme, 48 Vantablack gelecek şekilde sipariş verilmelidir.

Metallic Grey
Metalik Gri
10Fume / Füme
11Vantablack
48

voice | pastel

Product Code Ürün kodu	Product Name Ürün adı	Units Per Box Kutudaki adet	Units Per Package Koliadaki adet
611-02XX12-271	2M frame / 2M çerçeve	10	100
611-02XX13-271	3M frame / 3M çerçeve	10	100
611-02XX11-271	3/1M frame / 3/1M çerçeve	10	100
611-02XX12-226	3/1M frame / 3/2M çerçeve	10	100
611-02XX14-271	4M frame / 4M çerçeve	10	100
611-02XX17-271	7M frame / 7M çerçeve	10	100

* To select color of product please replace the XX with the color code: Matt White 62, Matt Cream 65, Matt Fume 67.

* Ürün renklerini belirtmek için ürün kodundaki XX yerine; 62 Mat Beyaz, 65 Mat Krem, 67 Mat Füme gelecek şekilde sipariş verilmelidir.

Matt White
Mat Beyaz
62Matt Cream
Mat Krem
65Matt Fume
Mat Füme
67

| Frame Size / Çerçeve Ebatları

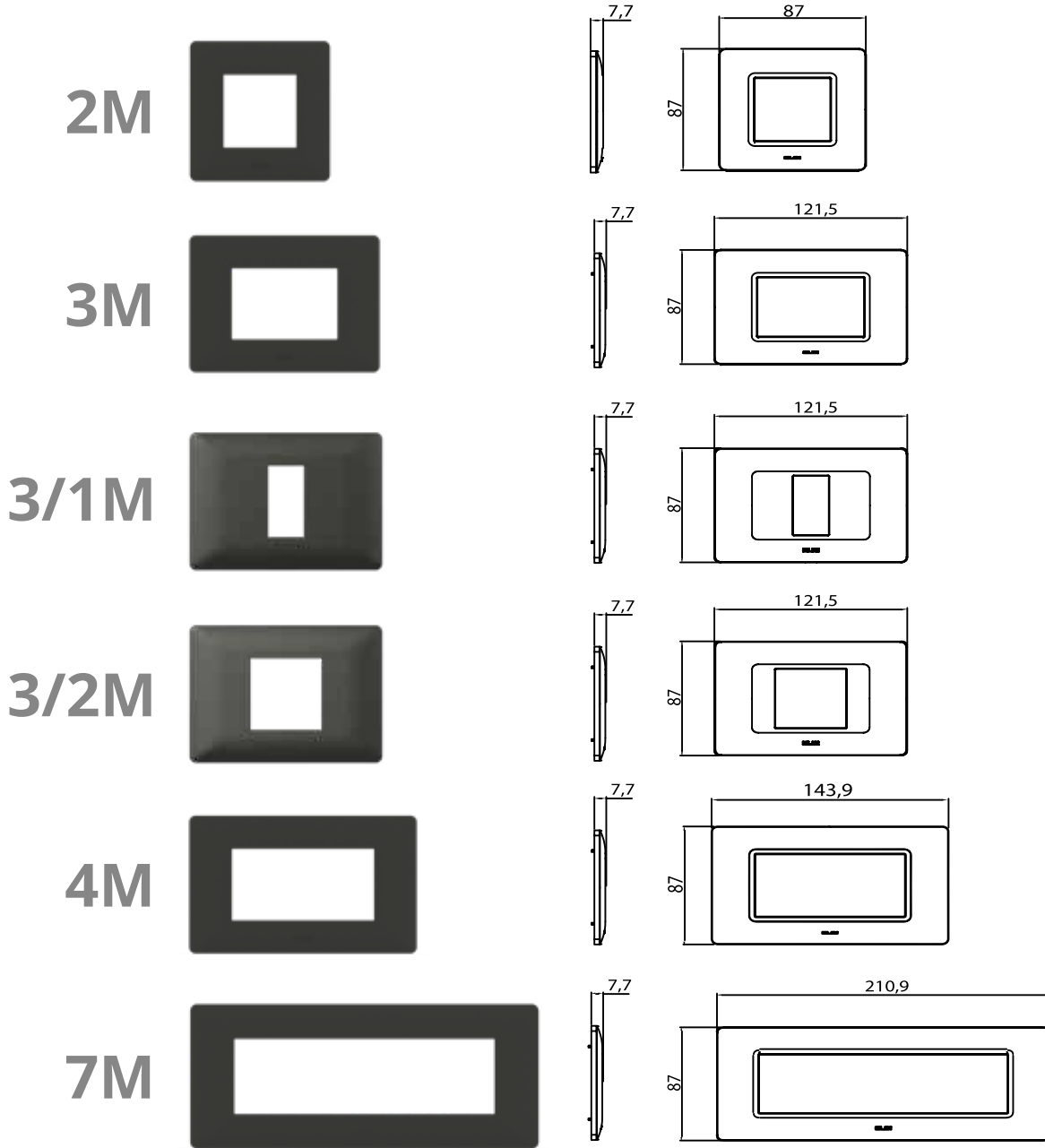

| Montage Schema / Montaj Şeması

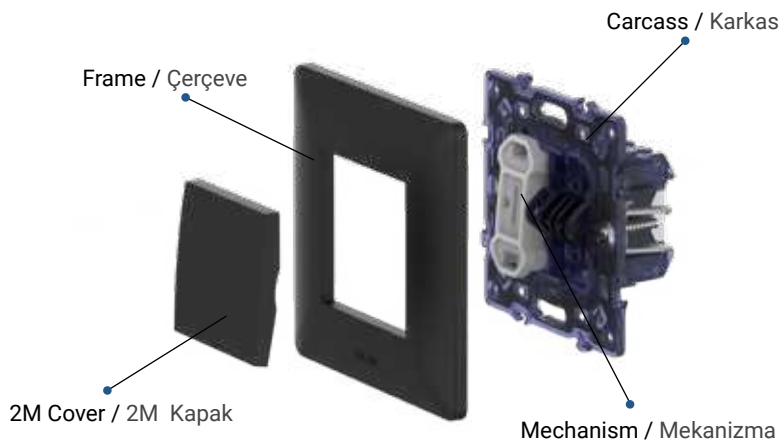

turn on the life

modastila

Remove Limits!

With Moda Stila's modular design, which allows you to use more than one function in a single frame, you can create any combination you want and create more space for life in your space by eliminating borders.

Sınırları Kaldırın!

Moda Stila'nın tek bir çerçevede birden fazla fonksiyonu bir arada kullanma imkanı sağlayan modüler tasarımıyla dilediğiniz kombinasyonu oluşturabilir, sınırları ortadan kaldırarak mekanınızda hayata daha çok yer açabilirsiniz.



ELBI
ELECTRIC



moda stila | natural

Product Code Ürün kodu	Product Name Ürün adı	Units Per Box Kutudaki adet	Units Per Package Koliadaki adet
611-01 XX 12-271	2M frame / 2M çerçeve	10	100
611-01 XX 13-271	3M frame / 3M çerçeve	10	100
611-01 XX 14-271	4M frame / 4M çerçeve	10	100
611-01 XX 17-271	7M frame / 7M çerçeve	10	100

* To select color of product please replace the **XX** with the color code: White **02**, Cream **03**.

* Ürün renklerini belirtmek için ürün kodundaki **XX** yerine; **02** Beyaz, **03** Krem gelecek şekilde sipariş verilmelidir.



White / Beyaz
02



Cream / Krem
03

moda stila | silverline

Product Code Ürün kodu	Product Name Ürün adı	Units Per Box Kutudaki adet	Units Per Package Koliadaki adet
611-01 XX 12-271	2M frame / 2M çerçeve	10	100
611-01 XX 13-271	3M frame / 3M çerçeve	10	100
611-01 XX 14-271	4M frame / 4M çerçeve	10	100
611-01 XX 17-271	7M frame / 7M çerçeve	10	100

* To select color of product please replace the **XX** with the color code: Metallic Grey **10**, Fume **11**, Titanium **14**, Vantablack **48**.

* Ürün renklerini belirtmek için ürün kodundaki **XX** yerine; **10** Metalik Gri, **11** Füme, **14** Titanyum, **48** Vantablack gelecek şekilde sipariş verilmelidir.



Metallic Grey
Metalik Gri
10



Fume / Füme
11



Titanium / Titanyum
14

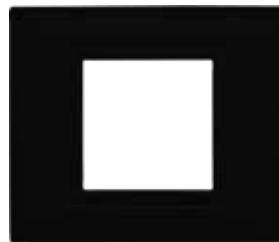

Vantablack
48

Montage Schema / Montaj Şeması

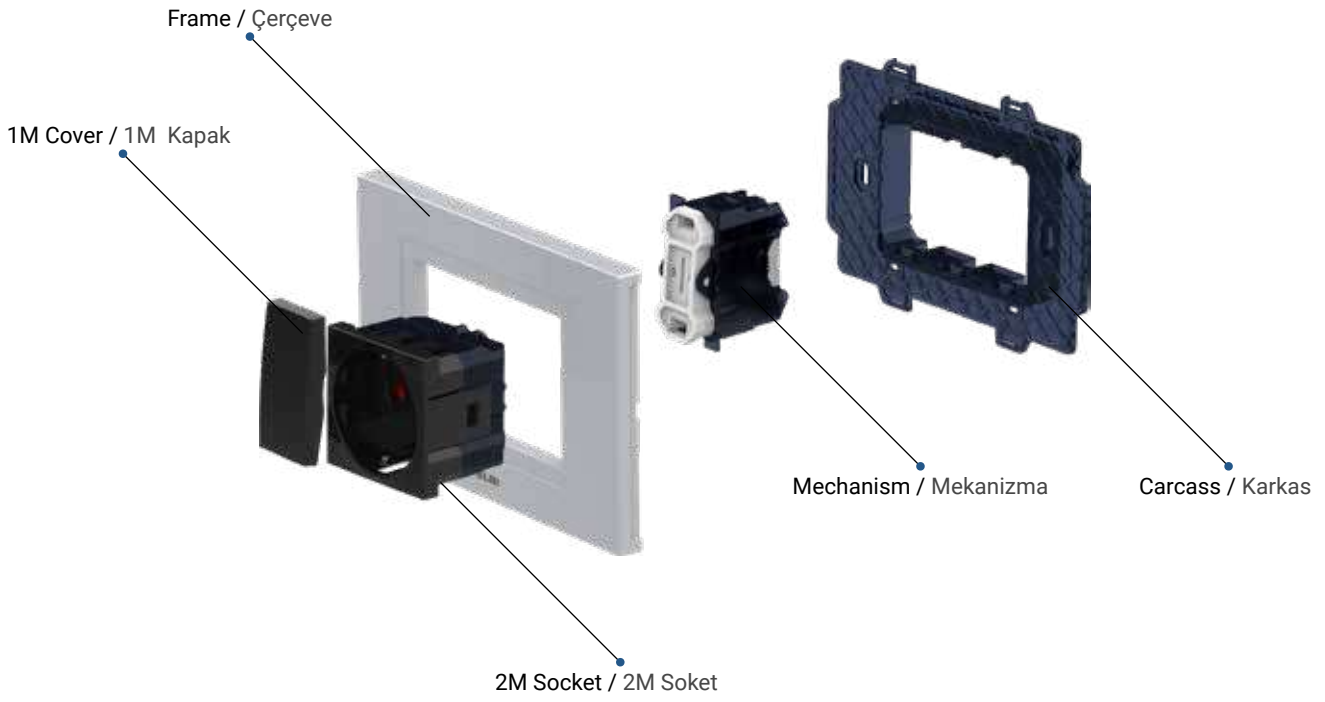

Frame Size / Çerçeve Ebatları

2M

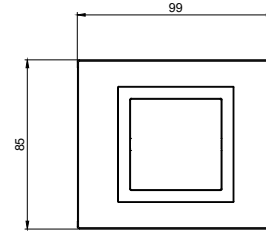
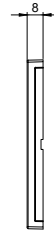

3M

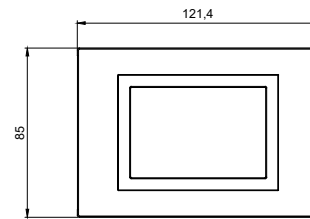

4M

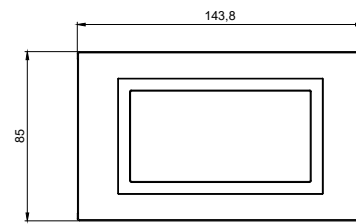

7M

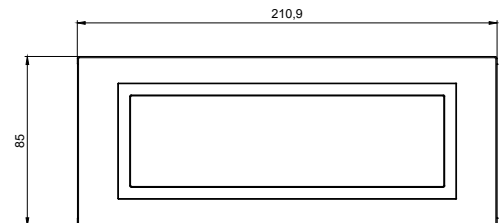
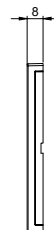

turn on the life

*moda*functions

fonksiyonlar

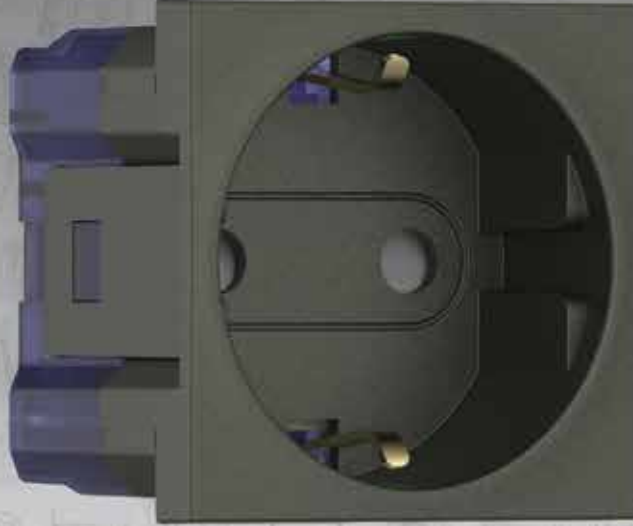

ELBI
ELECTRIC



1M - 1Gang 1Way
Switch Module

1M -
Anahtar Modül

611-00XXY1-200

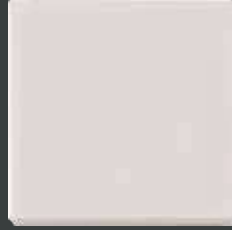

2M - 1Gang 1Way
Switch Module

2M -
Anahtar Modül

611-00XXY2-200



1M - 1Gang 1Way Switch
Illuminated Module

1M -
Işıklı Anahtar Modül

611-00XXY1-201



2M - 1Gang 1Way Switch
Illuminated Module

2M -
Işıklı Anahtar Modül

611-00XXY2-201



1M - Control Switch
Automatics Door Module

1M -
Kapı Otomatığı Modül

611-00XXY1-204

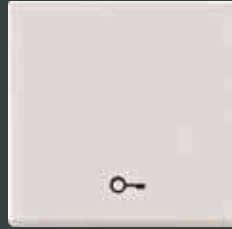

2M - Control Switch
Automatics Door Module

2M -
Kapı Otomatığı Modül

611-00XXY2-204



1M - Control Switch Door
Illuminated Module

1M - Işıklı Kapı Otomatığı
Modül

611-00XXY1-255

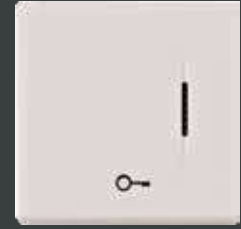

2M - Control Switch Door
Illuminated Module

2M - Işıklı Kapı Otomatığı
Modül

611-00XXY2-255



1M - Control Switch
Light Module

1M -
Light Modül

611-00XXY1-205

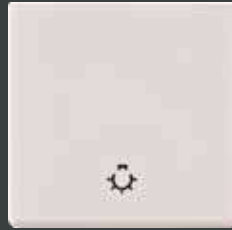

2M - Control Switch
Light Module

2M -
Light Modül

611-00XXY2-205



1M - Control Switch
Illuminated Module

1M -
Işıklı Light Modül

611-00XXY1-206

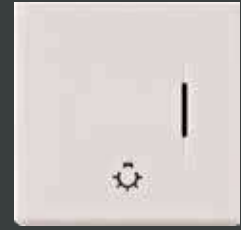

2M - Control Switch
Illuminated Module

2M -
Işıklı Light Modül

611-00XXY2-206



1M - 1Gang 2Way
Switch Module

1M -
Vavien

611-00XXY1-209

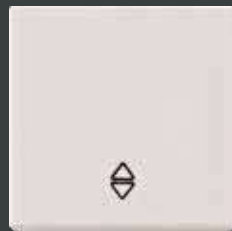

2M - 1Gang 2Way
Switch Module

2M -
Vavien

611-00XXY2-209



1M - 1Gang 2Way Switch
Illuminated Module

1M - Işıklı Vavien
Modül

611-00XXY1-210

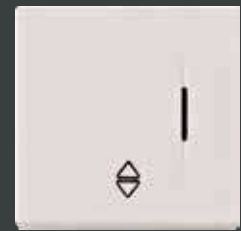

2M - 1Gang 2Way Switch
Illuminated Module

2M - Işıklı Vavien
Modül

611-00XXY2-210

*To select color of product please replace the XX with the color code: White 02, Cream 03, Metallic Grey 10, Fume 11, Titanium 14, Vantablack 48, Matt White 62, Matt Cream 65, Matt Fume 67.

*Ürün renklerini belirtmek için ürün kodundaki XX yerine; Beyaz 02, Krem 03, Metalik Gri 10, Füme 11, Titanyum 14, Vantablack 48, Mat Beyaz 62, Mat Krem 65, Mat Füme 67.



1M - Control switch
Bell module

1M -
Zil Modül

611-00XXY1-207

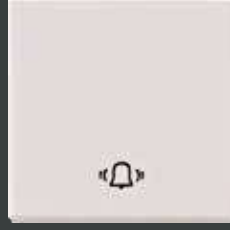

2M - Control switch
Bell module

2M -
Zil Modül

611-00XXY2-207



1M - Control switch
Bell illuminated module

1M -
Işıklı Zil Modül

611-00XXY1-256



2M - Control switch
Bell illuminated module

2M -
Işıklı Zil Modül

611-00XXY2-256



1M - 1Gang 2way
Switch intermediate module

1M -
Ara Vavien Modül

611-00XXY1-214



2M - 1Gang 2way
Switch intermediate module

2M -
Ara Vavien Modül

611-00XXY2-214



1M - Double pole
Switch module

1M - İki Kutuplu Anahtar
Modül

611-00XXY1-269

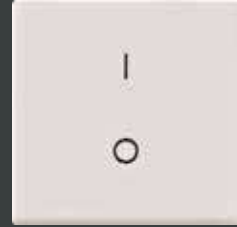

2M - Double pole
Switch module

2M - İki Kutuplu Anahtar
Modül

611-00XXY2-269

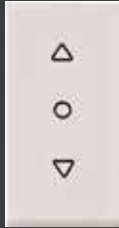

1M - Blind control switch
Light module

1M - Jaluzi Kumanda
Light Butonu Modül

611-00XXY1-197



1M - Blind control
Switch light module

1M - Jaluzi Kumanda
Light Butonu Modül

611-00XXY2-197



1M - Blind control switch
3 Positions module

1M -
3 Konumlu Jaluzi Modül

611-00XXY1-297



2M - Blind control switch
3 Positions module

2M -
3 Konumlu Jaluzi Modül

611-00XXY2-297

*To select color of product please replace the **XX** with the color code: White **02**, Cream **03**, Metallic Grey **10**, Fume **11**, Titanium **14**, Vantablack **48**, Matt White **62**, Matt Cream **65**, Matt Fume **67**.

*Ürün renklerini belirtmek için ürün kodundaki **XX** yerine; Beyaz **02**, Krem **03**, Metalik Gri **10**, Füme **11**, Titanyum **14**, Vantablack **48**, Mat Beyaz **62**, Mat Krem **65**, Mat Füme **67**.

Functions / Fonksiyonlar

Mechanism With Cover / Kapaklı Mekanizmalar



1M - Socket outlet

1M - Cihaz Priz

611-00XX31-215



1M - Socket outlet
Euro american

1M - Euro American
Cihaz Priz

611-00XX31-243



2M - Earth
Socket outlet

2M -
Topraklı Priz

611-00XX32-217



2M - UPS Socket outlet
With earth pin

2M - UPS Priz

611-00XX32-268



2M - Earth socket outlet
Earthed with hinged lid

2M -
Kapaklı Topraklı Priz

611-00XX32-218



1M - Numeris telephone
Socket outlet module
(RJ11 CAT 3)

1M - Nümeris Priz

611-00XX31-221



1M - Data socket
Outlet module
(RJ45 CAT 6)

1M - Data Priz Modül

611-00XX31-247



1M - Shielded Tv socket
outlet module through line

1M - TV Priz Geçişli

611-00XX31-272



1M - Shielded Tv socket
outlet module end of line

1M - TV Priz Sonlu

611-00XX31-273



1M - SAT Socket outlet
F type connector module

1M - Uydu Sat Priz
F Dişi Konnektör

611-00XX31-280



1M - TV + SAT Socket
Outlet Through Line

1M -
TV + SAT Priz Geçişli

611-00XX31-289



1M - TV + SAT Socket
Outlet End Of Line

1M -
TV SAT Priz Sonlu

611-00XX31-290



1M - Audio Socket

1M -
Müzik Yayın Priz

611-00XX31-241



2M - 300W RL Dimmer

2M -
300 W RL Dimmer

611-00XX32-292



2M - 300W RC Dimmer

2M -
300 W RC Dimmer

611-00XX32-142



1M - DND Internal Unit

1M - DND İç Ünite

611-00XX31-188



1M - Blind Cover

1M - Kör Kapak

611-00XX31-299



1M - USB Socket

1M - USB Prizi

611-00XX31-242



1M - HDMI Socket

1M - HDMI Priz

611-00XX31-284



2M - Child Protection
Universal Socket

2M - Çocuk Korumalı
Universal Priz

611-00XX32-342

*To select color of product please replace the **XX** with the color code: White **02**, Cream **03**, Metallic Grey **10**, Fume **11**, Titanium **14**, Vantablack **48**, Matt White **62**, Matt Cream **65**, Matt Fume **67**.

*Ürün renklerini belirtmek için ürün kodundaki **XX** yerine; Beyaz **02**, Krem **03**, Metalik Gri **10**, Füme **11**, Titanyum **14**, Vantablack **48**, Mat Beyaz **62**, Mat Krem **65**, Mat Füme **67**.

Functions / Fonksiyonlar



2M Double USB Socket Outlet 5V 2100 mA

2M İkilili USB Şarj Prizi 5V 2100 mA

611-00XX32-143



2M Double USB Socket Outlet (Type C+A) 5V 2400 mA

2M İkilili USB Şarj Prizi (Type C+A) 5V 2400 mA

611-00XX32-335

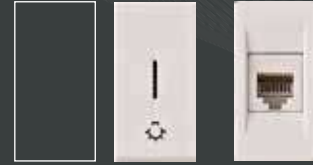

1M

1
MODULE

1
MODULE



2M



2
MODULE



2
MODULE



2M - RFID Energy Saver

611-00XX32-158

2M - Universal Energy Saver

611-00XX32-265

2M - Optic / Optik Energy Saver

611-00XX32-291



3M - RFID Energy Saver

611-00XX33-158

3M - Universal Energy Saver

611-00XX33-265

3M - Optic / Optik Energy Saver

611-00XX33-291



Optic and Universal PVC Energy Saver Card

Optik ve Universal PVC Energy Saver Kart

608-000000-291



Y = 3

Mechanism / Mekanizma



Y = 2

Cover / Kapak

*To select color of product please replace the XX with the color code: White 02, Cream 03, Metallic Grey 10, Fume 11, Titanium 14, Vantablack 48, Matt White 62, Matt Cream 65, Matt Fume 67.

*Ürün renklerini belirtmek için ürün kodundaki XX yerine; Beyaz 02, Krem 03, Metalik Gri 10, Füme 11, Titanyum 14, Vantablack 48, Mat Beyaz 62, Mat Krem 65, Mat Füme 67.

Functions / Fonksiyonlar

2M Earth Socket Outlet / 2M Topraklı Priz



Mechanism / Mekanizma



Cover / Kapak



Mechanism + Cover
Mekanizma + Kapak



Adapter + Mechanism
Adaptör + Mekanizma



Cover / Kapak



Adapter + Mechanism + Cover
Adaptör + Mekanizma + Kapak

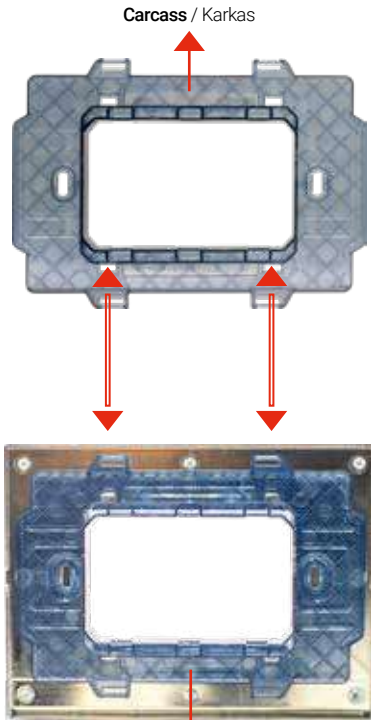

Mekanizma / Mechanism

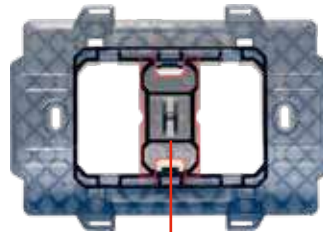

Adapter / Adaptör

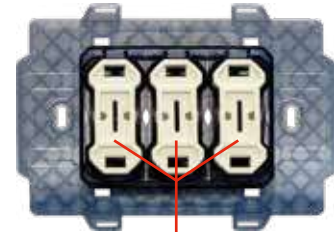

Mekanizma / Mechanism

turn on the life

VOX

The Beauty of Simplicity.

Vox Series captures the essence of minimalism with its simple design and elegant aesthetics. These sockets bring the elegance of simplicity to your home, freeing you from the design details that impress you so much.

Sadelğin Güzelliđi.

Vox Serisi, sade tasarımı ve zarif estetiđi ile minimalizmin özünü yakalıyor. Bu prizler, sizi fazlasıyla etkileyen tasarım detaylarından arındırarak, sadelikteki zarafeti evinize getiriyor.



ELBI
ELECTRIC

Color Options / Renk Seçenekleri

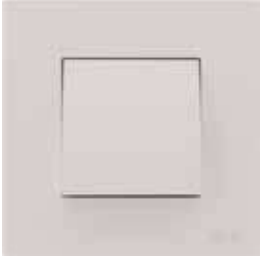
vox natural

WHITE
BEYAZ
611-050231-200



CREAM
KREM
611-050331-200

vox silverline

METALLIC GREY
METALİK GRI
611-051031-200



TITANIUM
TİTANYUM
611-051431-200

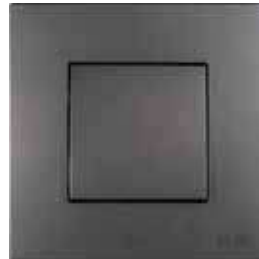

LATTE (ANTHRACITE)
LATTE (ANTRASİT)
611-054031-200



FUME
FÜME
611-051131-200



VANTABLACK
611-054831-200



IVORY
FİLDİŞİ
611-052531-200



Color Options / Renk Seçenekleri

vox woodline

CHERRY
KIRAZ
611-050631-200



NEW OAK
YENİ MEŞE
611-050831-200



MAPLE
AKÇAĞAÇ
611-052731-200



WHITE OAK
BEYAZ MEŞE
611-054231-200



ANTIQU WALNUT
ANTİK CEVİZ
611-050431-200



VOX

turn on the life

VOXfunctions

fonksiyonlar

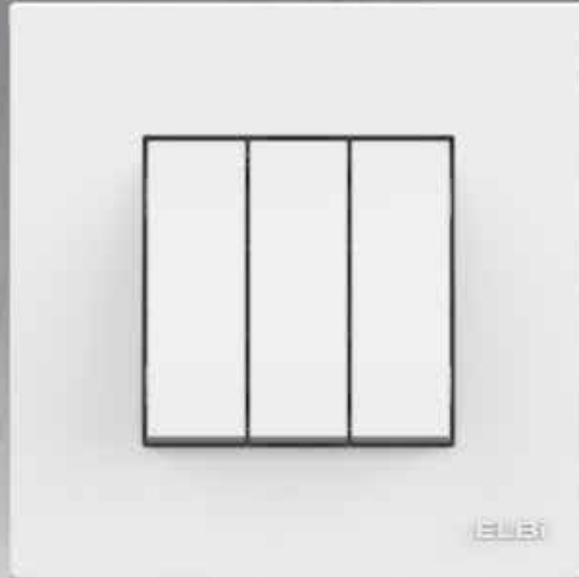

Functions / Fonksiyonlar



1Gang 1Way Switch
Anahtar

611-05XX31-200



1Gang 1Way Switch
Illuminated
Işıklı Anahtar

611-05XX31-201

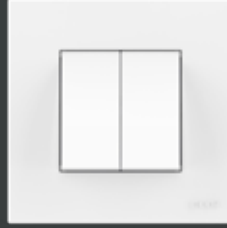

2Gang 1Way Switch
Komütatör

611-05XX32-202

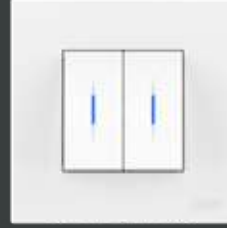

2Gang 1Way Switch
Illuminated
Işıklı Komütatör

611-05XX32-203



Control Switch Door
Kapı Otomatığı

611-05XX31-204



Control Switch Light
Light Anahtarı

611-05XX31-205



Control Switch
Illuminated Light
Işıklı Light Anahtar

611-05XX31-206



Control Switch Bell
Zil Anahtarı

611-05XX31-207

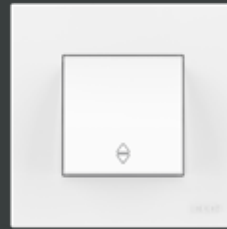

1Gang 2Way Switch
Vavien

611-05XX31-209



1 Gang 2 Way
Switch Illuminated
Işıklı Vavien

611-05XX31-210



2 Gang 2 Way Switch
Komütatör Vavien

611-05XX32-211



1 Gang 2 Way
Switch Intermediate
Ara Vavien (Permütatör)

611-05XX31-214

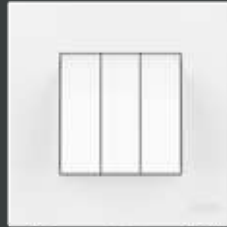

3 Gang 1 Way Switch
Üçlü Anahtar

611-05XX31-254

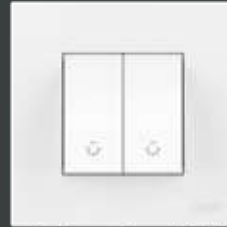

2 Gang 1 Way
Control Switch Light
Komütatör Light

611-05XX32-257



Double Pole Switch
İki Kutuplu Anahtar

611-05XX31-269

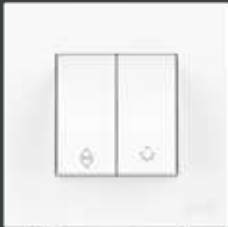

Vavien + Light Switch
Vavien + Light Anahtar

611-05XX32-281



Blind Control Switch
(3 Position)
Tek Düğmeli Jaluzi
Anahtarı (3 Konumlu)

611-05XX31-297



Socket Outlet Earthed
Topraklı Priz
Çocuk Korumalı

611-05XX32-217



Socket Outlet Earthed
With Hinged Lid
Kapaklı Topraklı Priz
Çocuk Korumalı

611-05XX32-218



Ups Socket Outlet
With Earthed Pin
UPS Priz Çocuk Korumalı

611-05XX32-268

* To select color of product please replace the XX with the color code: White 02, Cream 03, Metallic Grey 10, Fume 11, Titanium 14, Latte (Anthracite) 40, Ivory 25, Vantablack 48, Cherry 06, New Oak 08, Maple 27, White Oak 42, Antique Walnut 04.

* Ürün renklerini belirtmek için ürün kodundaki XX yerine; 02 Beyaz, 03 Krem, 10 Metalik Gri, 11 Füme, 14 Titanyum, 40 Latte (Antrasit), 25 Fildişi, 48 Vantablack, 06 Kiraz, 08 Yeni Meşe, 27 Akçaağaç, 42 Beyaz Meşe, 04 Antik Ceviz gelecek şekilde sipariş verilmelidir.

Functions / Fonksiyonlar



Double USB Charger 5V 2,1A
USB Şarj Prizi 5V 2,1A Çiftli

611-05XX32-143



Double USB Charger (Type C+A) 5V 2,4A
USB Şarj Prizi (Type C+A) 5V 2,4A Çiftli

611-05XX32-335



Tv + SAT Socket Outlet Through Line
TV + SAT Prizi - Geçişli

611-05XX32-289

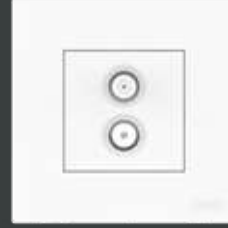

Tv + SAT Socket Outlet End Of Line
TV + SAT Prizi - Sonlu

611-05XX32-290



SAT Socket Outlet F Type
Uydu Prizi (F dişi Konnektörlü)

611-05XX32-280

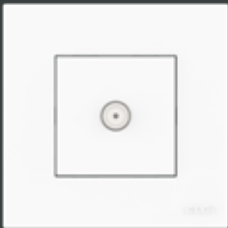

Shielded Tv Socket Outlet End Of Line
TV Prizi Ekranlı-Sonlu

611-05XX32-273

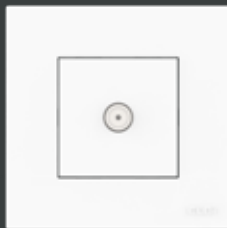

Shielded Tv Socket Outlet Through Line
TV Prizi Ekranlı-Geçişli

611-05XX32-272



Numeris Telephone Socket Outlet (RJ11 CAT3)
Nümeris Prizi (RJ11 CAT3)

611-05XX32-221



Double Numeris Telephone Socket Outlet (2 x RJ11 CAT3)
İkili Nümeris Prizi (2 x RJ11 CAT3)

611-05XX32-222



Data Socket Outlet (RJ45 CAT6)
Data Prizi (RJ45 CAT6)

611-05XX32-247



Data + Numeris Telephone Socket Outlet (RJ45 CAT6+ RJ11 CAT3)
Data Prizi + Nümeris Priz (RJ45 CAT6+ RJ11 CAT3)

611-05XX32-249



Double Data Socket Outlet (2 x RJ45 CAT6)
İkili Data Prizi (2 x RJ45 CAT6)

611-05XX32-248



HDMI Socket
HDMI Priz

611-05XX32-284



USB Connector (Data Transfer)
USB Konnektör (Veri Transferi)

611-05XX32-242



Fiber Optic Data Socket
Fiber Optik Data Prizi

611-05XX32-300



Numeris Socket Without Jack
Nümeris Prizi Jaksız

611-05XX32-282



Data Socket Without Jack
Data Prizi Jaksız

611-05XX32-296



RFID Energy Saver
Rfid Enerji Saver

611-05XX32-158



RC Dimmer (300W)
RC Dimmer (300W)

611-05XX32-142



Dimmer (300W)
Dimmer (300W)

611-05XX32-292

* To select color of product please replace the XX with the color code: White 02, Cream 03, Metallic Grey 10, Fume 11, Titanium 14, Latte (Anthracite) 40, Ivory 25, Vantablack 48, Cherry 06, New Oak 08, Maple 27, White Oak 42, Antique Walnut 04.

* Ürün renklerini belirtmek için ürün kodundaki XX yerine; 02 Beyaz, 03 Krem, 10 Metalik Gri, 11 Füme, 14 Titanyum, 40 Latte (Antrasit), 25 Fildişi, 48 Vantablack, 06 Kiraz, 08 Yeni Meşe, 27 Akçaağaç, 42 Beyaz Meşe, 04 Antik Ceviz gelecek şekilde sipariş verilmelidir.

Functions / Fonksiyonlar



Dnd Outer Unite
Dnd Dış Ünite

611-05 **XX**32-165



Energy Saver Modul Emtı
(No PCB)
Ener.Sav.Mod.Boş (No PCB)

611-05 **XX**32-170



Led Light
Led Light

611-05 **XX**32-184



Led Light Switch
Led Light Anahtarlı

611-05 **XX**32-185



DND Inside Unit
DND İç Ünite

611-05 **XX**32-188



Blind Control Switch Button
Jaluzi Kumanda Light Butonu

611-05 **XX**31-197



Double Pole Switch
Illuminated
Işıklı İki Kutuplu Anahtar

611-05 **XX**32-236



Door Automatics
Işıklı Kapı Otomatığı

611-05 **XX**32-255



Control Switch
Bell Illuminated
Işıklı Zil

611-05 **XX**32-256



Universal Energy Saver
Üniversal Energy Saver

611-05 **XX**32-265



Optic Energy Saver
Optik Algılamalı Energy Saver

611-05 **XX**32-291



Child Protection Universal Socket
Çocuk Korumalı Üniversal Priz

611-05 **XX**32-342



Double Socket Outlet Earthed
2'li Sıva Altı Topraklı Priz

611-05 **XX**32-907

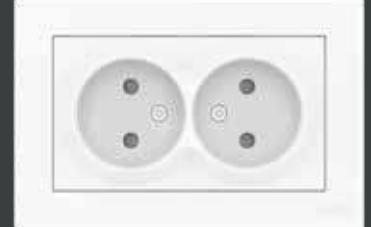

Double Socket Outlet Without Earthed
2'li Sıva Altı Priz

611-05 **XX**32-908

* To select color of product please replace the **XX** with the color code: White **02**, Cream **03**, Metallic Grey **10**, Fume **11**, Titanium **14**, Latte (Anthracite) **40**, Ivory **25**, Vantablack **48**, Cherry **06**, New Oak **08**, Maple **27**, White Oak **42**, Antique Walnut **04**.

* Ürün renklerini belirtmek için ürün kodundaki **XX** yerine; **02** Beyaz, **03** Krem, **10** Metalik Gri, **11** Füme, **14** Titanyum, **40** Latte (Antrasit), **25** Fildişi, **48** Vantablack, **06** Kiraz, **08** Yeni Meşe, **27** Akçaağaç, **42** Beyaz Meşe, **04** Antik Ceviz gelecek şekilde sipariş verilmelidir.

Gang Frames / Çoklu Çerçevesler



Single Frame / Tekli Çerçeve
611-05XX12-271



2 Gang Frame / İkili Çerçeve
611-05XX12-226



3 Gang Frame / Üçlü Çerçeve
611-05XX12-227



4 Gang Frame / Dörtlü Çerçeve
611-05XX12-228



5 Gang Frame / Beşli Çerçeve
611-05XX12-250

◆ Multiple frames can be used horizontally and vertically. / Çoklu çerçeveler yatay ve dikey olarak kullanılabilir.

Montage Schema / Montaj Şeması

Mechanism / Mekanizma

Cover / Kapak

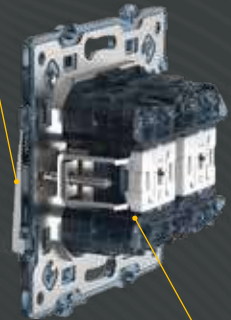
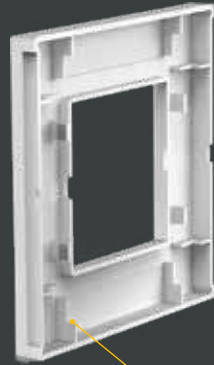

Cover / Kapak

Frame / Çerçeve

Frame / Çerçeve

Mechanism / Mekanizma

* To select color of product please replace the XX with the color code: White 02, Cream 03, Metallic Grey 10, Fume 11, Titanium 14, Latte (Anthracite) 40, Ivory 25, Vantablack 48, Cherry 06, New Oak 08, Maple 27, White Oak 42, Antique Walnut 04.

* Ürün renklerini belirtmek için ürün kodundaki XX yerine; 02 Beyaz, 03 Krem, 10 Metalik Gri, 11 Füme, 14 Titanyum, 40 Latte (Antrasit), 25 Fildişi, 48 Vantablack, 06 Kiraz, 08 Yeni Meşe, 27 Akçaağaç, 42 Beyaz Meşe, 04 Antik Ceviz gelecek şekilde sipariş verilmelidir.

turn on the life

zena platin

The Power of Metal Met with Aesthetics.

Zena Platin is designed for you to make a difference with details..

Metalin Gücü Estetik ile Buluştu.

Zena Platin detaylarla fark yaratmanız için tasarlandı.



ELBI
ELECTRIC



INOX
İNOKS
30



CHROME
KROM
31



BLACK PEARL
SİYAH İNCİ
33



MATT GOLD
MAT ALTIN
35



GOLD
ALTIN
34



MATT CHROME
MAT KROM
36



ANTIQU BRASS
ANTİK PİRİNÇ
58



ANTIQU COPPER
ANTİK BAKIR
32



MATT BLACK
MAT SİYAH
37



Frames | Çerçeveseler

Product Code Ürün Kodu	Product Name Ürün Adı	Units per box Kutudaki Adet	Units per package Koliadaki Adet
500-07XX00-271	Single frame / Tekli Çerçeve	5	50
500-07XX00-226	2 frame / 2'li Çerçeve	5	50
500-07XX00-227	3 frame / 3'lü Çerçeve	5	30
500-07XX00-228	4 frame / 4'lü Çerçeve	5	30
500-07XX00-250	5 frame / 5'li Çerçeve	5	30
500-07XX00-252	6 frame / 6'lı Çerçeve	5	30

* To select color of product please replace the **XX** with the color code: Enox **30**, Chrome **31**, Antique Copper **32**, Black Pearl **33**, Gold **34**, Matt Gold **35**, Matt Chrome **36**, Matt Black **37**, Antique Brass **58**.

* Ürün renklerini belirtmek için ürün kodundaki **XX** yerine; **30** İnox, **31** Krom, **32** Antik bakır, **33** Siyah İnci, **34** Altın, **35** Mat Altın, **36** Mat Krom, **37** Mat Siyah, **58** Antik Pirinç, gelecek şekilde sipariş verilmelidir.

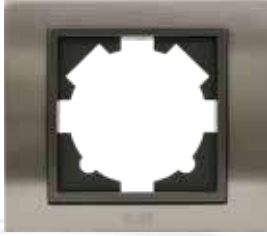

INOX / İNOKS
30



CHROME / KROM
31



ANTIQUÉ COPPER
ANTİK BAKIR
32



BLACK PEARL
SİYAH İNCİ
33



MATT BLACK
MAT SİYAH
37



MATT CHROME
MAT KROM
36



ANTIQUÉ BRASS
ANTİK PİRİNÇ
58

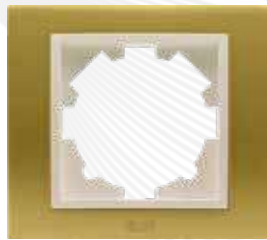

MATT GOLD
MAT ALTIN
35



GOLD / ALTIN
34

Cordons | Kordonlar

Product Code Ürün Kodu	Product Name Ürün Adı	Units per box Kutudaki Adet	Units per package Koliadaki Adet
603-000010-706	Metallic grey cordon / Metalik Gri Kordon	120	720
603-000011-706	Fume cordon / Füme Kordon	120	720
603-000014-706	Titanium cordon / Titanyum Kordon	120	720
603-000025-706	Ivory cordon / Fildişi Kordon	120	720
603-000040-706	Anthracite cordon / Antrasit Kordon	120	720
603-000048-706	Vantablack cordon / Vantablack Kordon	120	720

* Cordons are only can use for Arya and Zena Platin products. / Kordonlar Arya ve Zena Platin ürünleri için geçerlidir.

Montage Schema / Montaj Şeması

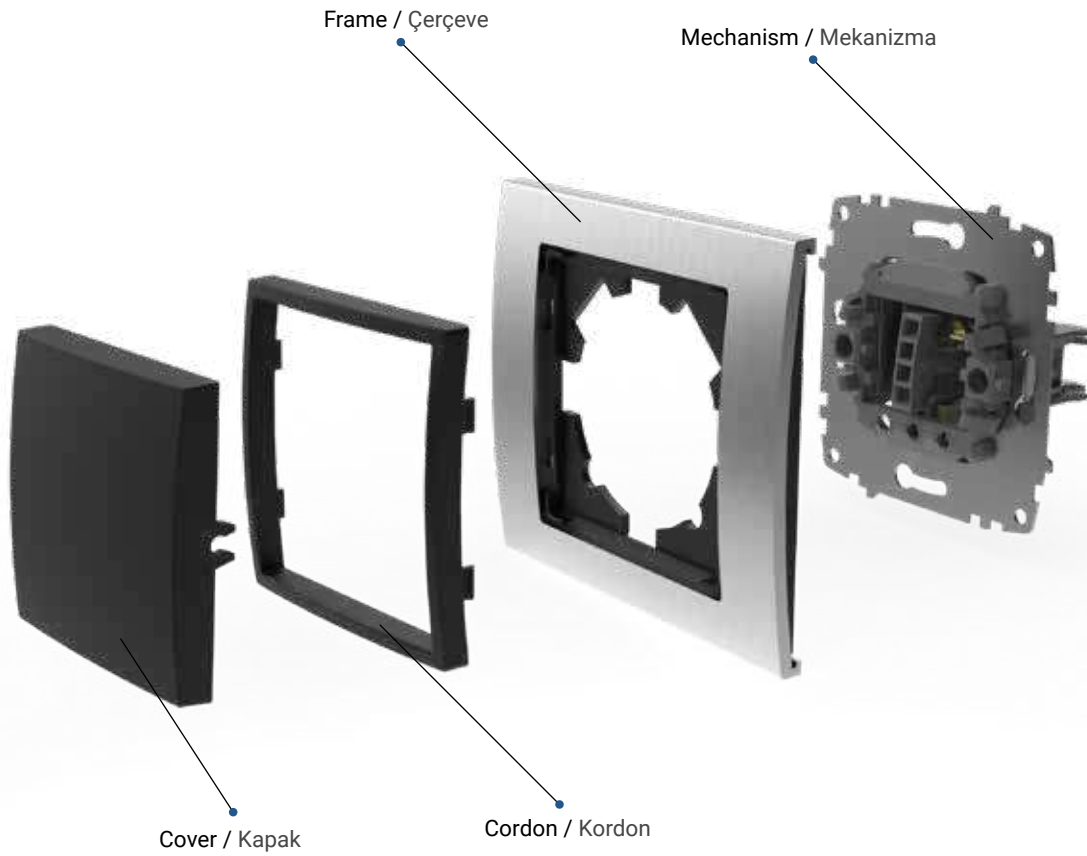

turn on the life

arya

Arya is closer to you than ever with its Wood, Glass, Aluminum and Marble options..

Arya ahşap, cam, alüminyum ve mermer seçenekleriyle size her zamankinden daha yakın.

ELBI
ELECTRIC

Aluminium / Alüminyum



GOLD / ALTIN
12



BRONZE / BRONZ
11



SILVER / GÜMÜŞ
10

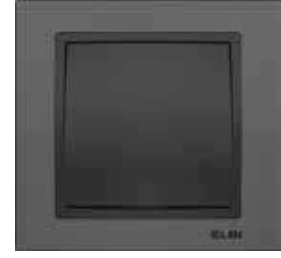

ONYX / ONİKS
13

Safe Glass / Cam



MATT WHITE
MAT BEYAZ
51



MATT BLACK
MAT SİYAH
37



KHAKI
KESE KAĞIDI
59

Marble / Mermer



KUMINITY
46



GRINITY
47

Wood / Ahşap



BAMBOO
BAMBU
50



AMERİKAN WALNUT
AMERİKAN CEVİZ
49

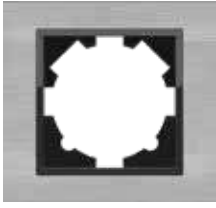

Frames / Çerçeveler

SILVER / GÜMÜŞ
10BRONZE / BRONZ
11GOLD / ALTIN
12ONYX / ONİKS
13KUMINITY
46GRINITY
47MATT WHITE
MAT BEYAZ
51

Aluminium / Alüminyum

Product Code Ürün Kodu	Product Name Ürün Adı	Units per box Kutudaki Adet	Units per package Koliadaki Adet
511-02XX00-271	Single Frame / Tekli Çerçeve	5	30
511-02XX00-226	2 Frame / 2'li Çerçeve	5	30
511-02XX00-227	3 Frame / 3'lü Çerçeve	5	30
511-02XX00-228	4 Frame / 4'lü Çerçeve	5	30

* To select color of product please replace the XX with the color code: Silver 10, Bronze 11, Gold 12, Onyx 13.

* Ürün renklerini belirtmek için ürün kodundaki XX yerine; 10 Gümüş, 11 Bronz, 12 Altın, 13 Oniks, gelecek şekilde sipariş verilmelidir.

Marble / Mermer

Product Code Ürün Kodu	Product Name Ürün Adı	Units per box Kutudaki Adet	Units per package Koliadaki Adet
511-02XX00-271	Single Frame / Tekli Çerçeve	5	30
511-02XX00-226	2 Frame / 2'li Çerçeve	5	30
511-02XX00-227	3 Frame / 3'lü Çerçeve	5	30
511-02XX00-228	4 Frame / 4'lü Çerçeve	5	30

* To select color of product please replace the XX with the color code: Kuminty 46, Grinity 47.

* Ürün renklerini belirtmek için ürün kodundaki XX yerine; 46 Kuminty, 47 Grinity, gelecek şekilde sipariş verilmelidir.

Safe Glass / Cam

Product Code Ürün Kodu	Product Name Ürün Adı	Units per box Kutudaki Adet	Units per package Koliadaki Adet
511-02XX00-271	Single Frame / Tekli Çerçeve	5	30
511-02XX00-226	2 Frame / 2'li Çerçeve	5	30
511-02XX00-227	3 Frame / 3'lü Çerçeve	5	30
511-02XX00-228	4 Frame / 4'lü Çerçeve	5	30

* To select color of product please replace the XX with the color code: Matt White 51, Matt Black 37, Khaki 59.

* Ürün renklerini belirtmek için ürün kodundaki XX yerine; 51 Mat Beyaz, 37 Mat Siyah, 59 Kese Kağıdı, gelecek şekilde sipariş verilmelidir.

Wood / Ahşap

Product Code Ürün Kodu	Product Name Ürün Adı	Units per box Kutudaki Adet	Units per package Koliadaki Adet
511-02XX00-271	Single Frame / Tekli Çerçeve	5	30
511-02XX00-226	2 Frame / 2'li Çerçeve	5	30
511-02XX00-227	3 Frame / 3'lü Çerçeve	5	30
511-02XX00-228	4 Frame / 4'lü Çerçeve	5	30

* To select color of product please replace the XX with the color code: American Walnut 49, Bamboo 50.

* Ürün renklerini belirtmek için ürün kodundaki XX yerine; 49 Amerikan Ceviz, 50 Bambu, gelecek şekilde sipariş verilmelidir.

MATT BLACK
MAT SİYAH
37KHAKI
KESE KAĞIDI
59AMERICAN WALNUT
AMERİKAN CEVİZ
49BAMBOO
BAMBU
50

Cordons | Kordonlar

Product Code Ürün Kodu	Product Name Ürün Adı	Units per box Kutudaki Adet	Units per package Koliadaki Adet
603-000010-706	Metallic grey cordon / Metalik Gri Kordon	120	720
603-000011-706	Fume cordon / Füme Kordon	120	720
603-000014-706	Titanium cordon / Titanyum Kordon	120	720
603-000025-706	Ivory cordon / Fildişi Kordon	120	720
603-000040-706	Anthracite cordon / Antrasit Kordon	120	720
603-000048-706	Vantablack cordon / Vantablack Kordon	120	720

* Cordons are only can use for Arya and Zena Platin products. / Kordonlar Arya ve Zena Platin ürünleri için geçerlidir.

Montage Schema / Montaj Şeması

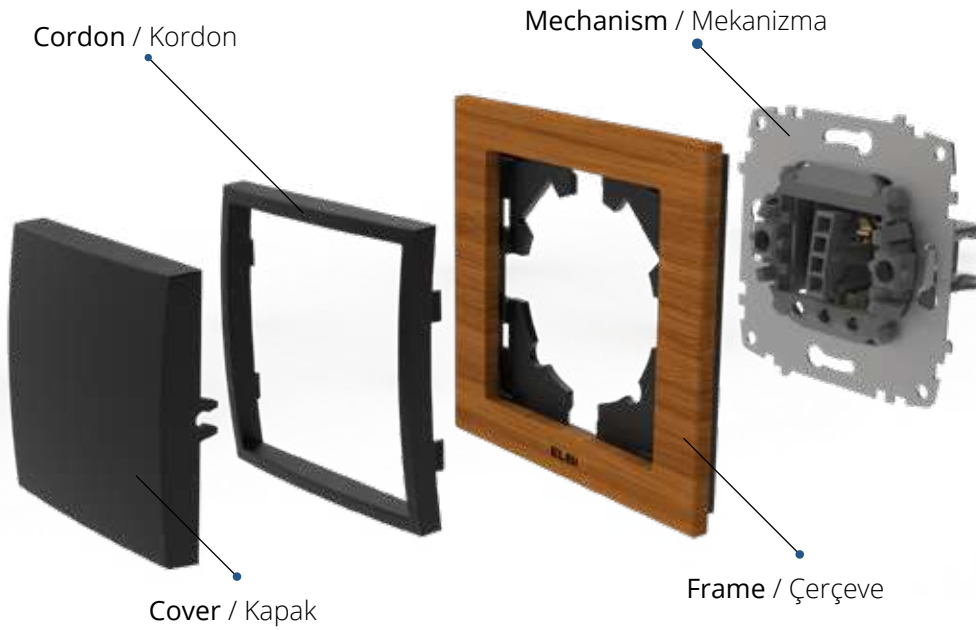

turn on the life

ELBI
★new

aryabold

The frame structure enlarged with the Arya Bold series both increases durability and fits perfectly into a modern home design. Its The Design where every detail has been considered, it stands out as an element that beautifies the interior of your home.

Arya Bold serisi ile büyüyen çerçeve yapısı hem dayanıklılığı artırıyor, hem de modern bir ev tasarımına mükemmel bir uyum sağlıyor. Her detayı düşünülmüş tasarımıyla, evinizin iç mekanını güzelleştiren bir unsur olarak öne çıkıyor.



ELBI
ELECTRIC

Aluminium / Alüminyum

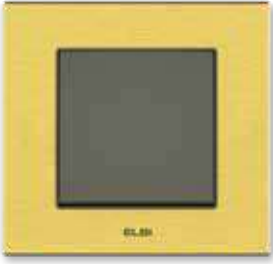

GOLD / ALTIN
12



BRONZE / BRONZ
11



SILVER / GÜMÜŞ
10



ONYX / ONİKS
13

Safe Glass / Cam



MATT WHITE
MAT BEYAZ
51



MATT BLACK
MAT SİYAH
37



KHAKI
KESE KAĞIDI
59

Wood / Ahşap



BAMBOO
BAMBU
50



AMERICAN WALNUT
AMERİKAN CEVİZ
49

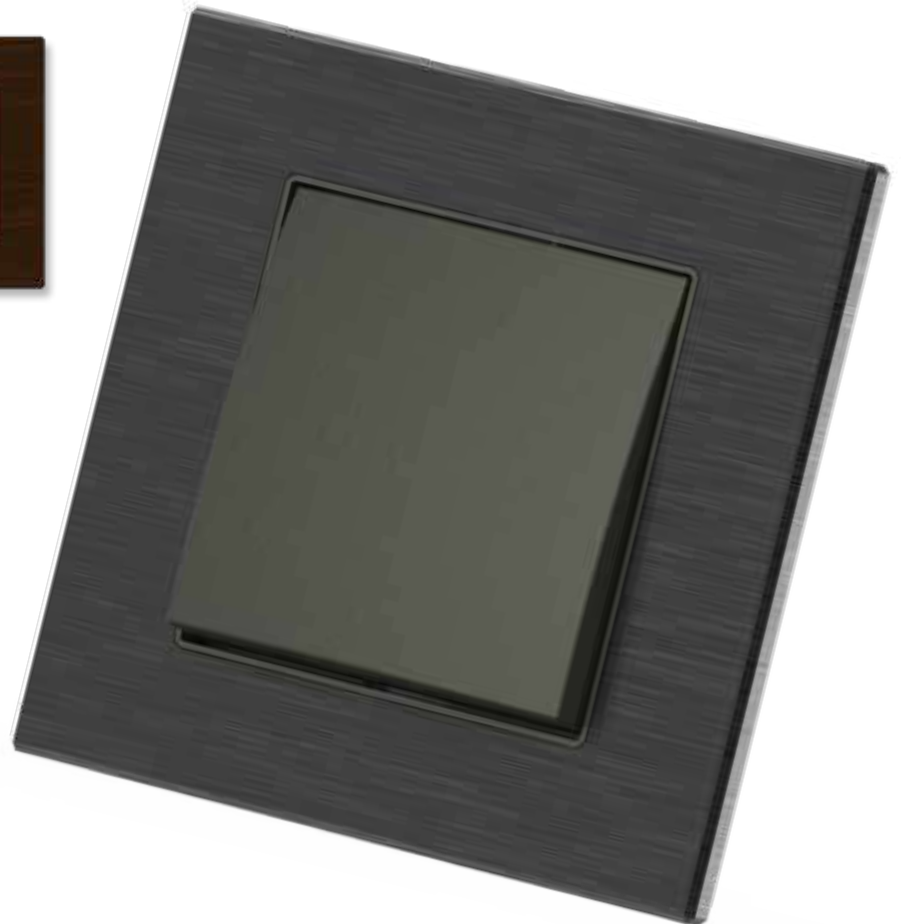

Frames / Çerçeveler

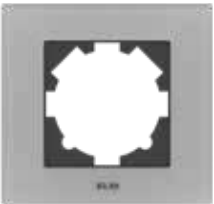
SILVER / GÜMÜŞ
10BRONZE / BRONZ
11GOLD / ALTIN
12ONYX / ONİKS
13MATT WHITE
MAT BEYAZ
51MATT BLACK
MAT SİYAH
37

Aluminium / Alüminyum

Product Code Ürün Kodu	Product Name Ürün Adı	Units per box Kutudaki Adet	Units per package Koliadaki Adet
511-05XX00-271	Single Frame / Tekli Çerçeve	1	5
511-05XX00-226	2 Frame / 2'li Çerçeve	1	5
511-05XX00-227	3 Frame / 3'lü Çerçeve	1	5
511-05XX00-228	4 Frame / 4'lü Çerçeve	1	5
511-05XX00-250	5 Frame / 5'li Çerçeve	1	5

* To select color of product please replace the XX with the color code: Silver 10, Bronze 11, Gold 12, Onyx 13.

* Ürün renklerini belirtmek için ürün kodundaki XX yerine; 10 Gümüş, 11 Bronz, 12 Altın, 13 Oniks, gelecek şekilde sipariş verilmelidir.

Safe Glass / Cam

Product Code Ürün Kodu	Product Name Ürün Adı	Units per box Kutudaki Adet	Units per package Koliadaki Adet
511-05XX00-271	Single Frame / Tekli Çerçeve	1	5
511-05XX00-226	2 Frame / 2'li Çerçeve	1	5
511-05XX00-227	3 Frame / 3'lü Çerçeve	1	5
511-05XX00-228	4 Frame / 4'lü Çerçeve	1	5
511-05XX00-250	5 Frame / 5'li Çerçeve	1	5

* To select color of product please replace the XX with the color code: Matt White 51, Matt Black 37, Khaki 59.

* Ürün renklerini belirtmek için ürün kodundaki XX yerine; 51 Mat Beyaz, 37 Mat Siyah, 59 Kese Kağıdı, gelecek şekilde sipariş verilmelidir.

Wood / Ahşap

Product Code Ürün Kodu	Product Name Ürün Adı	Units per box Kutudaki Adet	Units per package Koliadaki Adet
511-05XX00-271	Single Frame / Tekli Çerçeve	1	5
511-05XX00-226	2 Frame / 2'li Çerçeve	1	5
511-05XX00-227	3 Frame / 3'lü Çerçeve	1	5
511-05XX00-228	4 Frame / 4'lü Çerçeve	1	5
511-05XX00-250	5 Frame / 5'li Çerçeve	1	5

* To select color of product please replace the XX with the color code: American Walnut 49, Bamboo 50.

* Ürün renklerini belirtmek için ürün kodundaki XX yerine; 49 Amerikan Ceviz, 50 Bambu, gelecek şekilde sipariş verilmelidir.

* There may be differences in the patterns of wooden products. / Ahşap ürünlerin desenlerinde farklılıklar olabilir.

* Suitable for use with Zena and Vega modules. / Zena ve Vega modülleri ile kullanıma uygundur.

KHAKI
KESE KAĞIDI
59AMERICAN WALNUT
AMERİKAN CEVİZ
49BAMBOO
BAMBU
50

| Frame Size / Çerçeve Ölçüsü

aryabold

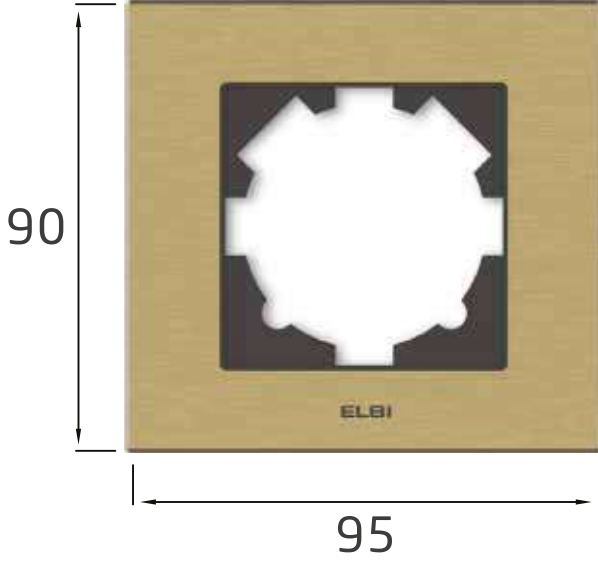

arya

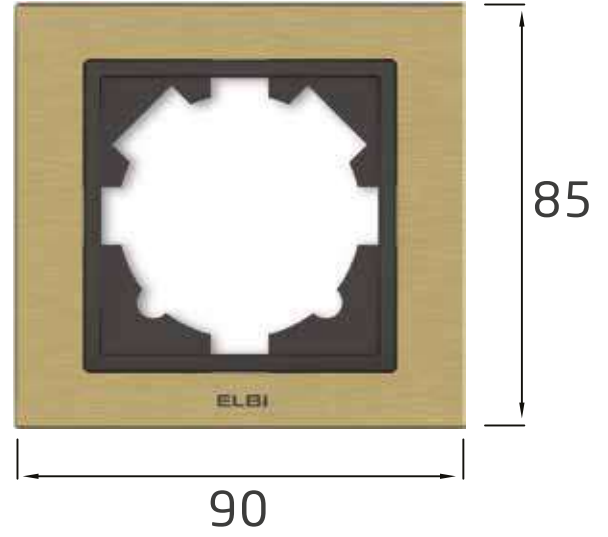

| Montage Schema / Montaj Şeması



turn on the life

ELBI
★new

aryaefekt

New Efekt in Arya.

Arya'da Yeni Efekt.



ELBI
ELECTRIC



MYSTIC GREY
MİSTİK GRİ
80



AUTHENTIC GREY
OTANTİK GRİ
81



CARBON BLACK
KARBON SİYAH
82



RUSTIC TITANIUM
RUSTİK TİTANYUM
83

Frames | Çerçeveseler

Product Code Ürün Kodu	Product Name Ürün Adı	Units per box Kutudaki Adet	Units per package Koliadaki Adet
511-07XX00-271	Single frame / Tekli Çerçeve	24	240
511-07XX00-226	2 frame / 2'li Çerçeve	12	120
511-07XX00-227	3 frame / 3'lü Çerçeve	12	120
511-07XX00-228	4 frame / 4'lü Çerçeve	12	72
511-07XX00-250	5 frame / 5'li Çerçeve	12	72
511-07XX00-252	6 frame / 6'li Çerçeve	12	72

* To select color of product please replace the XX with the color code: Mystic Grey 80, Authentic Grey 81, Carbon Black 82, Rustic Titanium 83.

* Ürün renklerini belirtmek için ürün kodundaki XX yerine; 80 Mistik Gri, 81 Otantik Gri, 82 Karbon Siyah, 83 Rustik Titanyum gelecek şekilde sipariş verilmelidir.

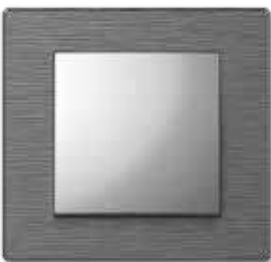

aryaefekt

turn on the life

ELBI
★new

aryanatural



ELBI
ELECTRIC

CREAM / KREM
03SNOWHITE / KARBELAZ
56

Frames | Çerçeveseler

Product Code Ürün Kodu	Product Name Ürün Adı	Units per box Kutudaki Adet	Units per package Kolidaki Adet
511-07XX00-271	Single frame / Tekli Çerçeve	24	240
511-07XX00-226	2 frame / 2'li Çerçeve	12	120
511-07XX00-227	3 frame / 3'lü Çerçeve	12	120
511-07XX00-228	4 frame / 4'lü Çerçeve	12	72
511-07XX00-250	5 frame / 5'li Çerçeve	12	72
511-07XX00-252	6 frame / 6'lı Çerçeve	12	72

* To select color of product please replace the XX with the color code: Cream 03, Snow White 56.

* Ürün renklerini belirtmek için ürün kodundaki XX yerine; 03 Krem, 56 Karbeyaz gelecek şekilde sipariş verilmelidir.

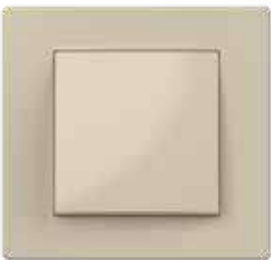
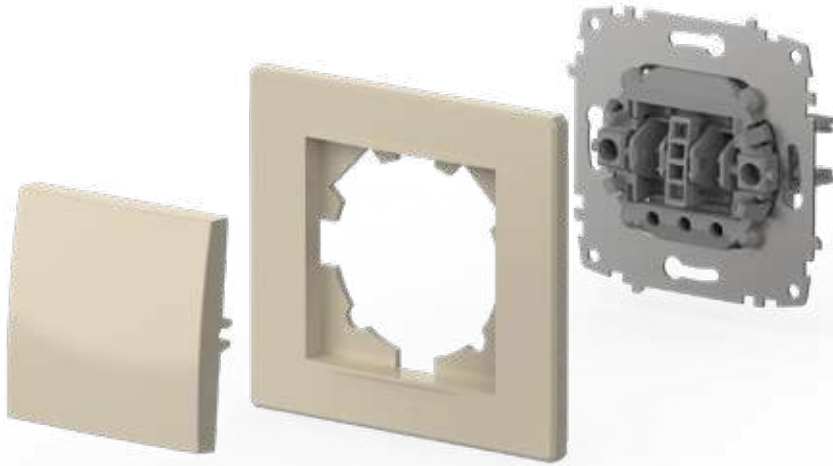
CREAM / KREM
03SNOWHITE / KARBELAZ
56

turn on the life

ELBI
★new

aryasilverline

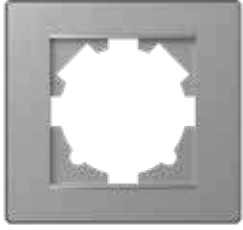

ELBI
ELECTRIC

METALLIC GREY / METALİK GRİ
10FUME / FÜME
11LATTE / LATTE
40VANTABLACK
48

Frames | Çerçeveler

Product Code Ürün Kodu	Product Name Ürün Adı	Units per box Kutudaki Adet	Units per package Kolideki Adet
511-07XX00-271	Single frame / Tekli Çerçeve	24	240
511-07XX00-226	2 frame / 2'li Çerçeve	12	120
511-07XX00-227	3 frame / 3'lü Çerçeve	12	120
511-07XX00-228	4 frame / 4'lü Çerçeve	12	72
511-07XX00-250	5 frame / 5'li Çerçeve	12	72
511-07XX00-252	6 frame / 6'lı Çerçeve	12	72

* To select color of product please replace the XX with the color code: Metallic Grey 10, Fume 11, Latte 40, Vantablack 48.

* Ürün renklerini belirtmek için ürün kodundaki XX yerine; 10 Metalik Gri, 11 Füme, 40 Latte, 48 Vantablack gelecek şekilde sipariş verilmelidir.

METALLIC GREY / METALİK GRİ
10FUME / FÜME
11LATTE / LATTE
40VANTABLACK
48

aryasilverline

turn on the life

zena

The Meeting of Elegance and Simplicity.

Lines that make a difference in your living spaces with their simple and stylish design.

Şıklık ve Sadeliğin Buluşması.

Sade ve şık tasarımıyla yaşam alanlarınızda fark yaratan çizgiler.

ELBI
ELECTRIC

Color Options / Renk Seçenekleri

zena natural

WHITE
BEYAZ
500-01**02**00-200



CREAM
KREM
500-01**03**00-200



SNOWHITE
KARBEBYAZ
500-01**56**00-200

zena silverline

METALLIC GREY
METALİK GRİ
500-01**10**00-200



TITANIUM
TİTANYUM
500-01**14**00-200



VANTABLACK
500-01**48**00-200



FUME
FÜME
500-01**11**00-200



IVORY
FİL DİŞİ
500-01**25**00-200



LATTE (ANTHRACITE)
LATTE (ANTRASİT)
500-01**40**00-200

zena

* To select color of product please replace the **XX** with the color code: White **02**, Cream **03**, Snow White **56**, Latte (Anthracite) **40**, M. Grey **10**, Fume **11**, Titanium **14**, Ivory **25**, Vantablack **48**, Maple **27**, New Cherry **28**, White Oak **42**, Mahogany **29**, Matt White **62**, Matt Cream **65**, Mat Fume **67**.

* Ürün renklerini belirtmek için ürün kodundaki **XX** yerine; **02** Beyaz, **03** Krem, **56** Karbeyaz, **40** Latte (Antrasit), **10** M. Gri, **11** Füme, **14** Titanyum, **25** Fildişi, **48** Vantablack, **28** Yeni Kiraz, **42** Beyaz Meşe, **29** Maun, **27** Akçaağaç, **62** Mat Beyaz, **65** Mat Krem, **67** Mat Füme gelecek şekilde sipariş verilmelidir.

Color Options / Renk Seçenekleri

zena woodline



MAPLE
AKÇAAĞAÇ
500-01**27**00-200



NEW CHERRY
YENİ KIRAZ
500-01**28**00-200



MAHOGANY
MAUN
500-01**29**00-200



WHITE OAK
BEYAZ MEŞE
500-01**42**00-200

zena pastel



MATT WHITE
MAT BEYAZ
500-01**62**00-200



MATT CREAM
MAT KREM
500-01**65**00-200

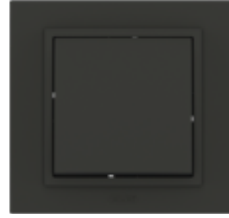

MATT FUME
MAT FÜME
500-01**67**00-200

* To select color of product please replace the **XX** with the color code: White **02**, Cream **03**, Snow White **56**, Latte (Anthracite) **40**, M. Grey **10**, Fume **11**, Titanium **14**, Ivory **25**, Vantablack **48**, Maple **27**, New Cherry **28**, White Oak **42**, Mahogany **29**, Matt White **62**, Matt Cream **65**, Mat Fume **67**.

* Ürün renklerini belirtmek için ürün kodundaki **XX** yerine; **02** Beyaz, **03** Krem, **56** Karbeyaz, **40** Latte (Antrasit), **10** M. Gri, **11** Füme, **14** Titanyum, **25** Fildişi, **48** Vantablack, **28** Yeni Kiraz, **42** Beyaz Meşe, **29** Maun, **27** Akçaağaç, **62** Mat Beyaz, **65** Mat Krem, **67** Mat Füme gelecek şekilde sipariş verilmelidir.

zenanatural

WHITE
BEYAZ
608-010200-271



WHITE
BEYAZ
609-010200-200



CREAM
KREM
608-010300-271

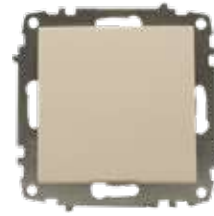

CREAM
KREM
609-010300-200

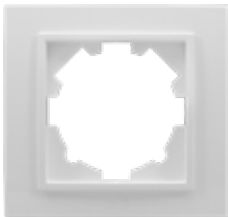

SNOW WHITE
KARBEYAZ
608-015600-271

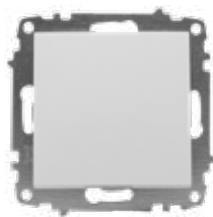

SNOW WHITE
KARBEYAZ
609-015600-200

zenasilverline

METALLIC GREY
METALİK GRİ
608-011000-271



METALLIC GREY
METALİK GRİ
609-011000-200



FUME
FÜME
608-011100-271



FUME
FÜME
609-011100-200



TITANIUM
TİTANYUM
608-011400-271



TITANIUM
TİTANYUM
609-011400-200



IVORY
FİL DİŞİ
608-012500-271

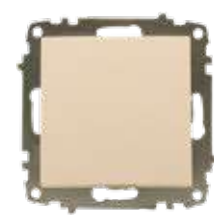

IVORY
FİL DİŞİ
609-012500-200



LATTE (ANTHRACITE)
LATTE (ANTRASİT)
608-014000-271



LATTE (ANTHRACITE)
LATTE (ANTRASİT)
609-014000-200



VANTABLACK
608-014800-271



VANTABLACK
609-014800-200

zenawoodline

MAPLE
AKÇAAĞAÇ
608-012700-271



MAPLE
AKÇAAĞAÇ
609-012700-200



NEW CHERRY
YENİ KIRAZ
608-012800-271



NEW CHERRY
YENİ KIRAZ
609-012800-200



MAHOGANY
MAUN
608-012900-271



MAHOGANY
MAUN
609-012900-200

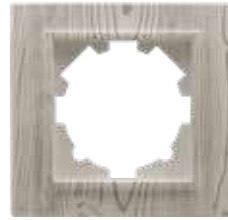

WHITE OAK
BEYAZ MEŞE
608-014200-271



WHITE OAK
BEYAZ MEŞE
609-014200-200

zenapastel

MATT WHITE
MAT BEYAZ
608-016200-271



MATT WHITE
MAT BEYAZ
609-016200-200



MATT CREAM
MAT KREM
608-016500-271



MATT CREAM
MAT KREM
609-016500-200



MATT FUME
MAT FÜME
608-016700-271



MATT FUME
MAT FÜME
609-016700-200

Montage Schema / Montaj Şeması

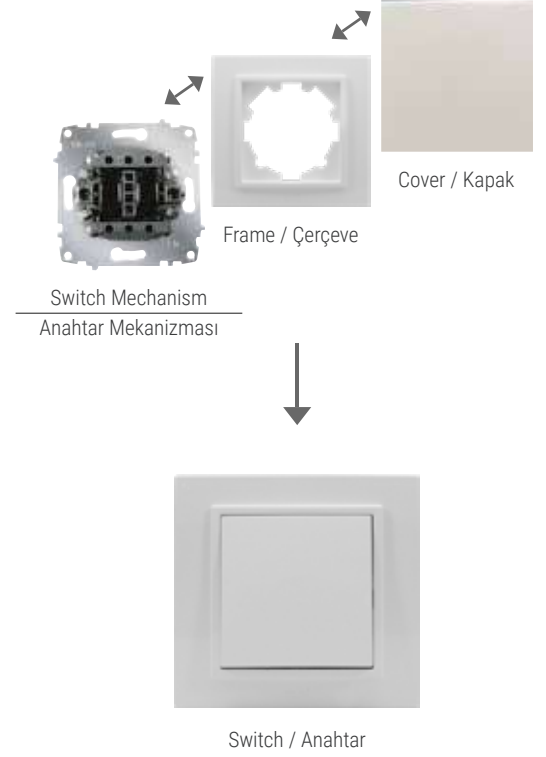
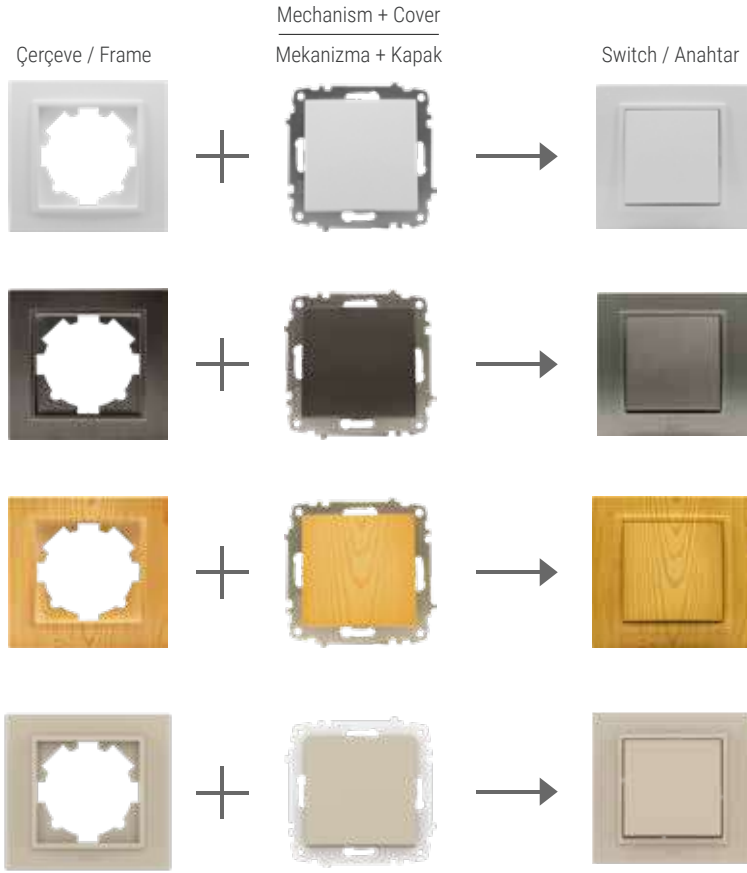

Quick Connect / Hızlı Bağlantı

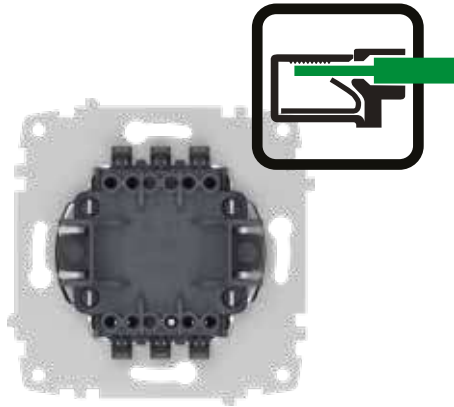

Quick Connect (screwless)
Hızlı Bağlantı (vidasız)

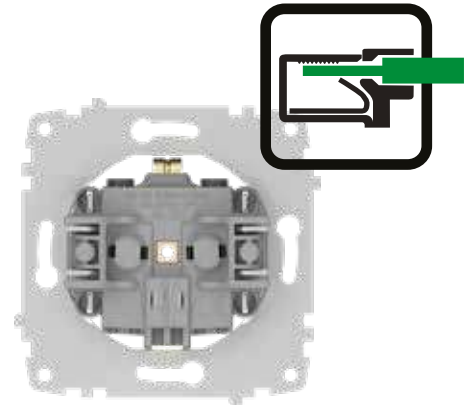

Quick Connect (screwless)
Hızlı Bağlantı (vidasız)

turn on the life

zenafunctions

fonksiyonlar



ELBI
ELECTRIC

Functions / Fonksiyonlar



1 Gang 1Way Switch
Anahtar

500-01XX00-200

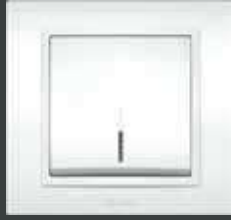

1 Gang 1Way
Switch Illuminated
Işıklı Anahtar

500-01XX00-201

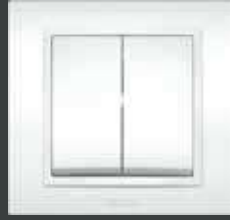

2Gang 1Way Switch
Komütatör

500-01XX00-202

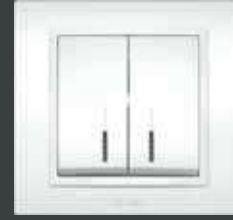

2Gang 1Way
Switch Illuminated
Işıklı Komütatör

500-01XX00-203



Control Switch Door
Kapı Otomatığı

500-01XX00-204



Control Switch Light
Light Anahtarı

500-01XX00-205



Control Switch
Illuminated Light
Işıklı Light Anahtar

500-01XX00-206



Control Switch Bell
Zil Anahtarı

500-01XX00-207



12V Illuminated Labelled
Control Switch Bell
12V Işıklı İsimli Zil

500-01XX00-208

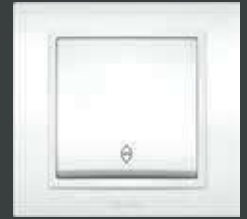

1 Gang 2Way Switch
Vavien

500-01XX00-209



1 Gang 2 Way
Switch Illuminated
Işıklı Vavien

500-01XX00-210



2 Gang 2 Way Switch
Komütatör Vavien

500-01XX00-211



1 Gang 2 Way
Switch Intermediate
Ara Vavien (Permütatör)

500-01XX00-214

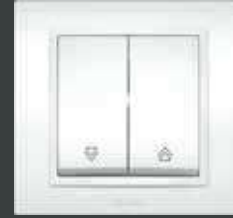

Blind Switch
Jaluzi Kumanda Anahtarı

500-01XX00-216



Double Pole
Switch Illuminated
İki Kutuplu Işıklı Anahtar

500-01XX00-236

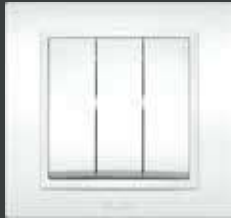

3 Gang 1 Way Switch
Üçlü Anahtar

500-01XX00-254



2 Gang 1 Way
Control Switch Light
Komütatör Light

500-01XX00-257



Blind Control Switch
(3 Position) Tek Düğmeli
Jaluzi Anahtarı (3 Konumlu)

500-01XX00-297



Double Pole Switch
İki Kutuplu Anahtar

500-01XX00-269



Vavien + Light Switch
Vavien + Light Anahtar

500-01XX00-281

■ Hızlı bağlantı seçimi için lütfen 01 yerine 03 yazınız. / For quick connection selection, please write 01 instead of 03.

* To select color of product please replace the XX with the color code: White 02, Cream 03, Snow White 56, Latte (Anthracite) 40, M. Grey 10, Fume 11, Titanium 14, Ivory 25, Vantablack 48, Maple 27, New Cherry 28, White Oak 42, Mahogany 29, Matt White 62, Matt Cream 65, Mat Fume 67.

* Ürün renklerini belirtmek için ürün kodundaki XX yerine; 02 Beyaz, 03 Krem, 56 Karbeyaz, 40 Latte (Antrasit), 10 M. Gri, 11 Füme, 14 Titanyum, 25 Fildişi, 48 Vantablack, 28 Yeni Kiraz, 42 Beyaz Meşe, 29 Maun, 27 Akçaağaç, 62 Mat Beyaz, 65 Mat Krem, 67 Mat Füme gelecek şekilde sipariş verilmelidir.

Functions / Fonksiyonlar



3Gang 1Way Hvac Switch
3'lü Klima Anahtarı

500-01XX00-279



Socket Outlet Without Earthed Priz

500-01XX00-215



Child Protection Socket Without Earthed Çocuk Korumalı Priz

500-01XX00-286



Socket Outlet Earthed Topraklı Priz

500-01XX00-217



Socket Outlet Earthed With Hinged Lid Kapaklı Topraklı Priz

500-01XX00-218



Socket Outlet Earthed Child Protection With Hinged Lid Çocuk Korumalı Kapaklı Topraklı Priz

500-01XX00-219



Socket Outlet Earthed Child Protection Çocuk Korumalı Topraklı Priz

500-01XX00-243



Child Protection Ups Socket Outlet Earthed Pin Çocuk Korumalı UPS priz

500-01XX00-263



Ups Socket Outlet With Earthed Pin UPS Priz

500-01XX00-268



Double USB Socket Outlet Earthed Child protection İkili USB Topraklı Priz Çocuk Korumalı

500-01XX00-317



SAT Socket Outlet F Type (RG 6 F Connector) Uydu Prizi (F dişi Konnektörlü) (RG 6 F Connector)

500-01XX00-180



TV Socket Outlet Through Line TV Priz - Geçişli

500-01XX00-224



TV Socket Outlet End Of Line TV Priz - Sonlu

500-01XX00-246



SAT Socket Outlet F Type Through Line Uydu Prizi Geçişli (F konnektörü)

500-01XX00-287



SAT Socket Outlet F Type End Of Line Uydu Prizi Sonlu (F konnektörü)

500-01XX00-288



TV + SAT Socket Outlet Through Line TV + SAT Prizi - Geçişli

500-01XX00-289



TV + SAT Socket Outlet End Of Line TV + SAT Prizi - Sonlu

500-01XX00-290



Shielded Tv Socket Outlet Without Resistance TV Prizi Ekranlı - Dirençsiz

500-01XX00-274



Cable Outlet Cover Kablo Çıkış Kapağı

500-01XX00-298



Shielded Tv Socket Outlet Through Line TV Prizi Ekranlı-Geçişli

500-01XX00-272

Hızlı bağlantı seçimi için lütfen **01** yerine **03** yazınız. / For quick connection selection, please write **01** instead of **03**.

* To select color of product please replace the **XX** with the color code: White **02**, Cream **03**, Snow White **56**, Latte (Anthracite) **40**, M. Grey **10**, Fume **11**, Titanium **14**, Ivory **25**, Vantablack **48**, Maple **27**, New Cherry **28**, White Oak **42**, Mahogany **29**, Matt White **62**, Matt Cream **65**, Mat Fume **67**.

* Ürün renklerini belirtmek için ürün kodundaki **XX** yerine; **02** Beyaz, **03** Krem, **56** Karbeyaz, **40** Latte (Antrasit), **10** M. Gri, **11** Füme, **14** Titanyum, **25** Fildişi, **48** Vantablack, **28** Yeni Kiraz, **42** Beyaz Meşe, **29** Maun, **27** Akçaağaç, **62** Mat Beyaz, **65** Mat Krem, **67** Mat Füme gelecek şekilde sipariş verilmelidir.

Functions / Fonksiyonlar



**Shielded Tv Socket Outlet
End Of Line**
TV Prizi Ekranlı-Sonlu

500-01XX00-273



SAT Socket Outlet F Type
Uydu Prizi
(F diři Konnektörlü)

500-01XX00-280



**Tv + Rad + SAT Socket
Outlet Through Line**
TV + Radyo + SAT - Geçişli

500-01XX00-233



**Tv + Rad + SAT Socket
Outlet End Of Line**
TV + Radyo + SAT - Sonlu

500-01XX00-234



VGA Socket
VGA Priz

500-01XX00-173



**Numeris Telephone
Socket Outlet** (RJ11 CAT3)
Nümeris Prizi (RJ11 CAT3)

500-01XX00-221



**Double Numeris Telephone
Socket Outlet** (2 x RJ11 CAT3)
İkili Nümeris Prizi (2 x RJ11 CAT3)

500-01XX00-222



Data Socket Outlet
(RJ45 Cat6)
Data Prizi (RJ45 CAT6)

500-01XX00-247



**Double Data Socket
Outlet** (2 x RJ45 CAT6)
İkili Data Prizi (2 x RJ45 CAT6)

500-01XX00-248



USB Connector (Data Transfer)
USB Konnektör (Veri Transferi)

500-01XX00-242



**Data + Numeris Telephone Socket
Outlet** (RJ45 CAT6 + RJ11 CAT3)
Data Prizi+Nümeris Priz
(RJ45 CAT6 + RJ11 CAT3)

500-01XX00-249



**Data + Numeris Telephone
Socket Outlet Without Jack**
Data prizi + Nümeris Priz Jaksız

500-01XX00-260



**Numeris Socket
Without Jack**
Nümeris Prizi Jaksız

500-01XX00-282



Data Socket Without Jack
Data Prizi Jaksız

500-01XX00-296

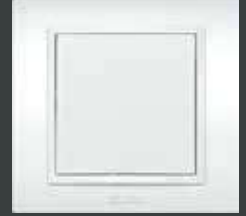

Blind Cover
Kör Kapak

500-01XX00-299



Fiber Optic Data Socket
Fiber Optik Data Prizi

500-01XX00-300



**Double Fiber Optic
Data Socket**
İkili Fiber Optik Data Prizi

500-01XX00-304



Double USB Charger 5V 2,1A
USB Şarj Prizi 5V 2,1A Çiftli

500-01XX00-143



**Double USB Charging
Socket** (Type C+A)
USB Şarj Prizi (Type C+A) Çiftli

500-01XX00-335



HDMI Socket
HDMI Priz

500-01XX00-284

* To select color of product please replace the XX with the color code: White 02, Cream 03, Snow White 56, Latte (Anthracite) 40, M. Grey 10, Fume 11, Titanium 14, Ivory 25, Vantablack 48, Maple 27, New Cherry 28, White Oak 42, Mahogany 29, Matt White 62, Matt Cream 65, Mat Fume 67.

* Ürün renklerini belirtmek için ürün kodundaki XX yerine; 02 Beyaz, 03 Krem, 56 Karbeyaz, 40 Latte (Antrasit), 10 M. Gri, 11 Füme, 14 Titanyum, 25 Fildiři, 48 Vantablack, 28 Yeni Kiraz, 42 Beyaz Meşe, 29 Maun, 27 Akçağaç, 62 Mat Beyaz, 65 Mat Krem, 67 Mat Füme gelecek şekilde sipariş verilmelidir.

Functions / Fonksiyonlar



Double USB(Type C+A) Socket Outlet Earthed Child protection
İkili USB(Type C+A) Topraklı Priz Çocuk Korumalı

500-01XX00-334



Double USB Charging HDMI Socket
İkili USB Şarj HDMI Prizi

500-01XX00-337



Relay Motion Sensor
Röleli Hareket Sensörü

500-01XX00-262



Triac Motion Sensor
Triyaklı Hareket Sensörü

500-01XX00-264



Dimmer 500W
Dimmer 500W

500-01XX00-212



Dimmer Illuminated (1000W)
Işıklı Dimmer (1000W)

500-01XX00-192

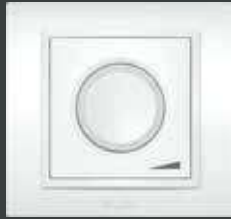

Dimmer (1000W)
Dimmer (1000W)

500-01XX00-112

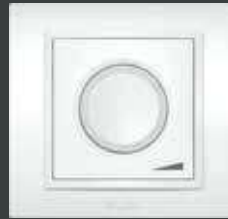

1-10V Dimmer
1-10V Dimmer

500-01XX00-316

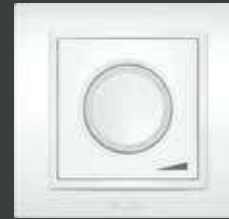

5-300W RC Dimmer
5-300W RC Dimmer

500-01XX00-310



220V Ventilator Control Switch 200W
220V Fan Dimmer 200W

500-01XX00-278

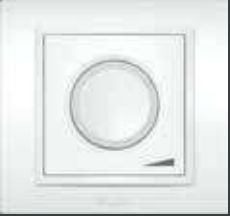

RC Led dimmer 5-60W
RC Led dimmer 5-60W

500-01XX00-308



Rf Energy Saver
Rf Enerji Saver

500-01XX00-318



Rfid Energy Saver
Rfid Enerji Saver

500-01XX00-158



Mechanical Energy Saving Suitable with Slim Card
İnce Kartlı Mekanik Enerji Saver

500-01XX00-319



Mechanical Energy Saver
Mekanik Enerji Saver

500-01XX00-266

IP44

An IP44 rating means that your product will be protected from solid particles that are over 1mm in size and from low velocity sprays of water from every direction.

IP44 derecesine sahip 1 ürün, 1mm'den büyük katı cisimlere ve her yönde sıçrayan suya karşı korumalıdır.

ELBİ
★new



IP44 1Gang 1Way Switch
IP44 Anahtar

500-08XX00-200



IP44 2Gang 1Way Switch
IP44 Komütatör

500-08XX00-202



IP44 Socket Outlet Earthed With Hinged Lid
IP44 Kapaklı Topraklı Priz

500-08XX00-218



IP44 Socket Outlet Earthed Child Protection With Hinged Lid
IP44 Çocuk Korumalı Kapaklı Topraklı Priz

500-08XX00-219

* To select color of product please replace the XX with the color code: White 02, Cream 03, Snow White 56, Latte (Anthracite) 40, M. Grey 10, Fume 11, Titanium 14, Ivory 25, Vantablack 48, Maple 27, New Cherry 28, White Oak 42, Mahogany 29, Matt White 62, Matt Cream 65, Mat Fume 67.

* Ürün renklerini belirtmek için ürün kodundaki XX yerine; 02 Beyaz, 03 Krem, 56 Karbeyaz, 40 Latte (Antrasit), 10 M. Gri, 11 Füme, 14 Titanyum, 25 Fildişi, 48 Vantablack, 28 Yeni Kiraz, 42 Beyaz Meşe, 29 Maun, 27 Akçaağaç, 62 Mat Beyaz, 65 Mat Krem, 67 Mat Füme gelecek şekilde sipariş verilmelidir.

Gang Frames / Çoklu Çerçevesler



Single Frame / Tekli Çerçeve
608-01XX00-271



Red Child Protection Ups
Socket Outlet Earthed Pin M+C
Kırmızı Çocuk
Korunmalı UPS Priz M+K

609-012600-263



Red Ups Socket Outlet
Earthed Pin M+C
Kırmızı UPS Priz M+K

609-012600-268



Double Socket Outlet Without Earthed
İkili Sıva Altı Priz

500-01XX00-908

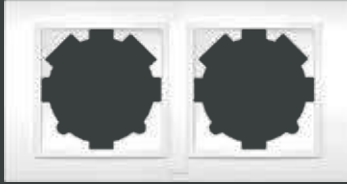

2 Gang Frame / İkili Çerçeve
500-01XX00-226



Double Socket Outlet Earthed
İkili Sıva Altı Topraklı Priz

500-01XX00-907

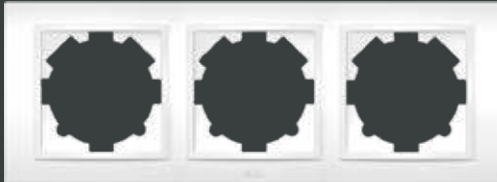

3 Gang Frame / Üçlü Çerçeve
500-01XX00-227

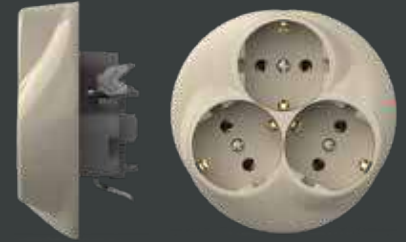

Flush Mounted 3G Earthed Socket Outlet
Sıvaaltı Üçlü Topraklı Priz

500-00XX00-819

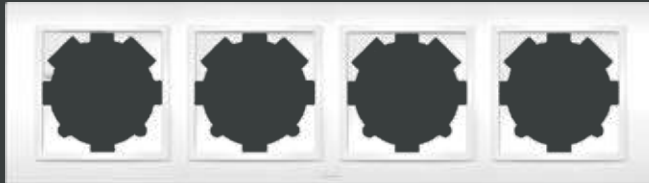

4 Gang Frame / Dörtlü Çerçeve
500-01XX00-228



5 Gang Frame / Beşli Çerçeve
500-01XX00-250



6 Gang Frame / Altılı Çerçeve
500-01XX00-252



Surface Mounting Box
Sıva Üstü Kasa

500-01XX00-253

◆ Multiple frames can be used horizontally and vertically. / Çoklu çerçevesler yatay ve dikey olarak kullanılabilir.

■ Hızlı bağlantı seçimi için lütfen 01 yerine 03 yazınız. / For quick connection selection, please write 01 instead of 03.

* To select color of product please replace the XX with the color code: White 02, Cream 03, Snow White 56, Latte (Anthracite) 40, M. Grey 10, Fume 11, Titanium 14, Ivory 25, Vantablack 48, Maple 27, New Cherry 28, White Oak 42, Mahogany 29, Matt White 62, Matt Cream 65, Mat Fume 67.

* Ürün renklerini belirtmek için ürün kodundaki XX yerine; 02 Beyaz, 03 Krem, 56 Karbeyaz, 40 Latte (Antrasit), 10 M. Gri, 11 Füme, 14 Titanyum, 25 Fildişi, 48 Vantablack, 28 Yeni Kiraz, 42 Beyaz Meşe, 29 Maun, 27 Akçaağaç, 62 Mat Beyaz, 65 Mat Krem, 67 Mat Füme gelecek şekilde sipariş verilmelidir.

turn on the life

vega

Vega series creates eye-catching spaces with its elegant design.

Zarif tasarımı ile Vega serisi göz dolduran mekanlar yaratır.



ELBI
ELECTRIC

Color Options / Renk Seçenekleri

vega natural

WHITE
BEYAZ
510-01**02**00-200

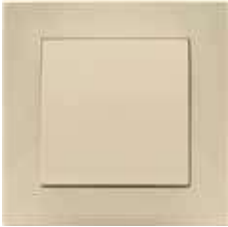

CREAM
KREM
510-01**03**00-200

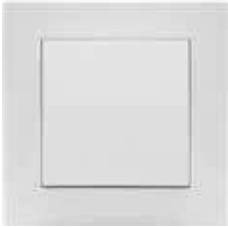

SNOWHITE
KARBEBYAZ
510-01**56**00-200

vega silverline

METALLIC GREY
METALİK GRI
510-01**10**00-200



TITANIUM
TİTANYUM
510-01**14**00-200



VANTABLACK
510-01**48**00-200



FUME
FÜME
510-01**11**00-200

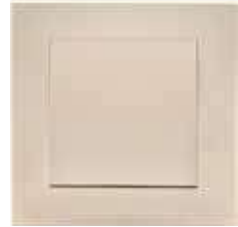

IVORY
FİL DİŞİ
510-01**25**00-200



LATTE (ANTHRACITE)
LATTE (ANTRASİT)
510-01**40**00-200

vega

* To select color of product please replace the **XX** with the color code: White **02**, Cream **03**, Snow White **56**, Latte (Anthracite) **40**, M. Grey **10**, Fume **11**, Titanium **14**, Ivory **25**, Vantablack **48**, Maple **27**, New Cherry **28**, White Oak **42**, Mahogany **29**, Matt White **62**, Matt Cream **65**, Mat Fume **67**.

* Ürün renklerini belirtmek için ürün kodundaki **XX** yerine; **02** Beyaz, **03** Krem, **56** Karbeyaz, **40** Latte (Antrasit), **10** M. Gri, **11** Füme, **14** Titanyum, **25** Fildişi, **48** Vantablack, **28** Yeni Kiraz, **42** Beyaz Meşe, **29** Maun, **27** Akçaağaç, **62** Mat Beyaz, **65** Mat Krem, **67** Mat Füme gelecek şekilde sipariş verilmelidir.

Color Options / Renk Seçenekleri

vega woodline



MAPLE
AKÇAAĞAÇ
510-01**27**00-200



NEW CHERRY
YENİ KIRAZ
510-01**28**00-200



MAHOGANY
MAUN
510-01**29**00-200



WHITE OAK
BEYAZ MEŞE
510-01**42**00-200

vega pastel



MATT WHITE
MAT BEYAZ
510-01**62**00-200



MATT CREAM
MAT KREM
510-01**65**00-200

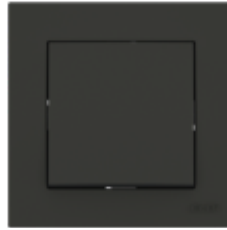

MATT FUME
MAT FÜME
510-01**67**00-200

* To select color of product please replace the XX with the color code: White 02, Cream 03, Snow White 56, Latte (Anthracite) 40, M. Grey 10, Fume 11, Titanium 14, Ivory 25, Vantablack 48, Maple 27, New Cherry 28, White Oak 42, Mahogany 29, Matt White 62, Matt Cream 65, Mat Fume 67.

* Ürün renklerini belirtmek için ürün kodundaki XX yerine; 02 Beyaz, 03 Krem, 56 Karbeyaz, 40 Latte (Antrasit), 10 M. Gri, 11 Füme, 14 Titanyum, 25 Fildişi, 48 Vantablack, 28 Yeni Kiraz, 42 Beyaz Meşe, 29 Maun, 27 Akçaağaç, 62 Mat Beyaz, 65 Mat Krem, 67 Mat Füme gelecek şekilde sipariş verilmelidir.

veganatural

WHITE
BEYAZ
510-010200-271



WHITE
BEYAZ
609-010200-200

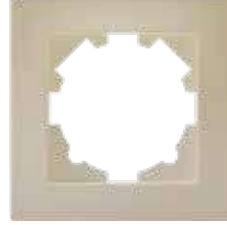

CREAM
KREM
510-010300-271



CREAM
KREM
609-010300-200

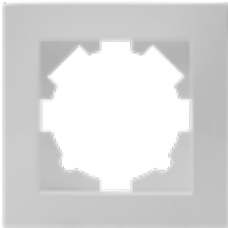

SNOW WHITE
KARBEYAZ
510-015600-271



SNOW WHITE
KARBEYAZ
609-015600-200

vegasilverline

METALLIC GREY
METALİK GRİ
510-011000-271



METALLIC GREY
METALİK GRİ
609-011000-200



FUME
FÜME
510-011100-271



FUME
FÜME
609-011100-200



TITANIUM
TİTANYUM
510-011400-271



TITANIUM
TİTANYUM
609-011400-200

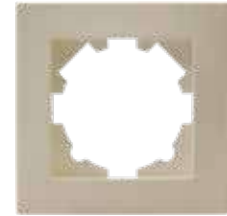

IVORY
FİL DİŞİ
510-012500-271

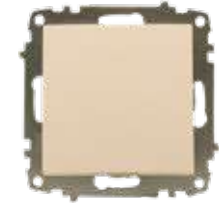

IVORY
FİL DİŞİ
609-012500-200



LATTE (ANTHRACITE)
LATTE (ANTRASİT)
510-014000-271



LATTE (ANTHRACITE)
LATTE (ANTRASİT)
609-014000-200

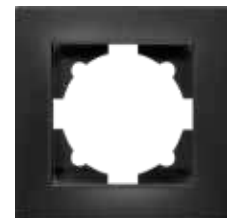

VANTABLACK
510-014800-271



VANTABLACK
609-014800-200

vegawoodline

MAPLE
AKÇAAĞAÇ
510-012700-271



MAPLE
AKÇAAĞAÇ
609-012700-200



NEW CHERRY
YENİ KIRAZ
510-012800-271



NEW CHERRY
YENİ KIRAZ
609-012800-200



MAHOGANY
MAUN
510-012900-271



MAHOGANY
MAUN
609-012900-200



WHITE OAK
BEYAZ MEŞE
510-014200-271



WHITE OAK
BEYAZ MEŞE
609-014200-200

vegapastel

MATT WHITE
MAT BEYAZ
510-016200-271



MATT WHITE
MAT BEYAZ
609-016200-200



MATT CREAM
MAT KREM
510-016500-271



MATT CREAM
MAT KREM
609-016500-200



MATT FUME
MAT FÜME
510-016700-271



MATT FUME
MAT FÜME
609-016700-200

Montage Schema / Montaj Şeması

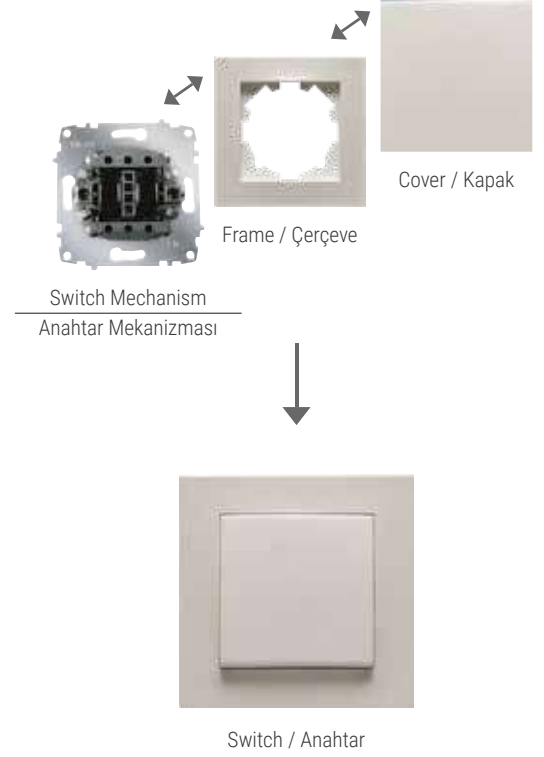
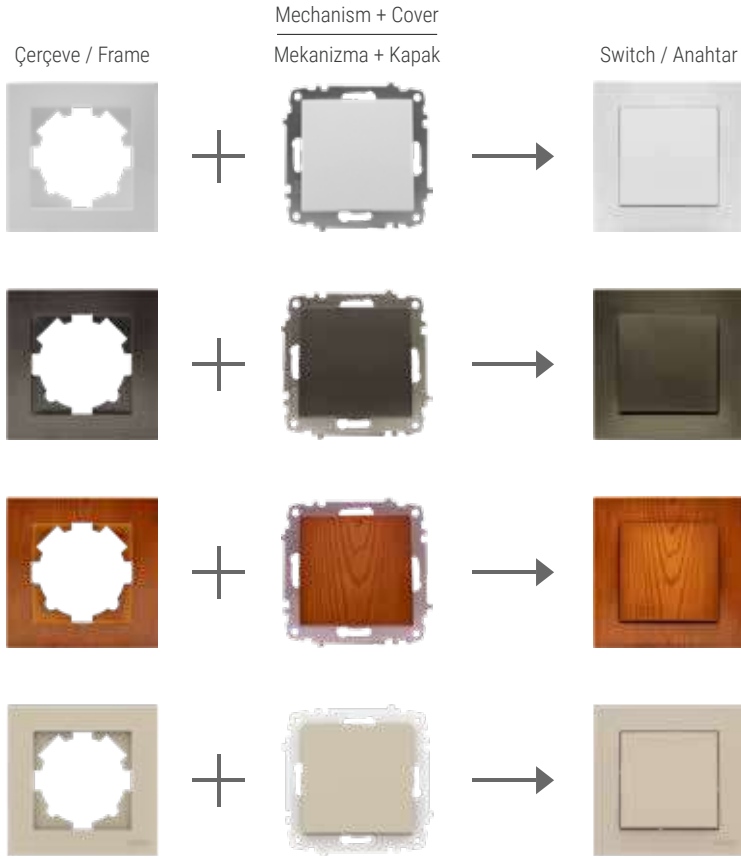

Quick Connect / Hızlı Bağlantı

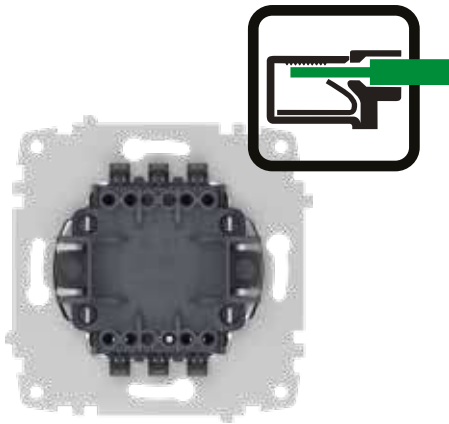

Quick Connect (screwless)
Hızlı Bağlantı (vidasız)

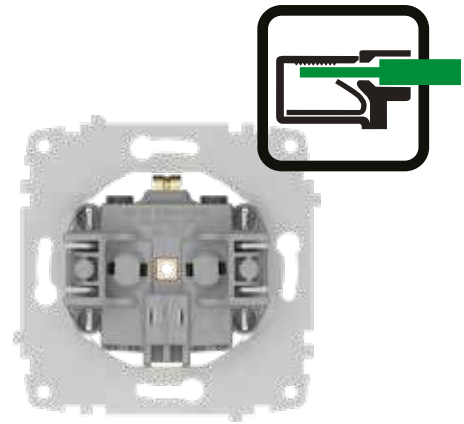

Quick Connect (screwless)
Hızlı Bağlantı (vidasız)

turn on the life

vegafunctions

fonksiyonlar



ELBI
ELECTRIC

Functions / Fonksiyonlar

1Gang 1Way Switch
Anahtar

510-01XX00-200

1Gang 1Way Switch
Illuminated
Işıklı Anahtar

510-01XX00-201

2Gang 1Way Switch
Komütatör

510-01XX00-202

2Gang 1Way Switch
Illuminated
Işıklı Komütatör

510-01XX00-203

Control Switch Door
Kapı Otomatığı

510-01XX00-204

Control Switch Light
Light Anahtarı

510-01XX00-205

Control Switch
Illuminated Light
Işıklı Light Anahtar

510-01XX00-206

Control Switch Bell
Zil Anahtarı

510-01XX00-207

12V Illuminated Labeled
Control Switch Bell
12V Işıklı İsimli Zil

510-01XX00-208

1Gang 2Way Switch
Vavien

510-01XX00-209

1 Gang 2 Way
Switch Illuminated
Işıklı Vavien

510-01XX00-210

2 Gang 2 Way Switch
Komütatör Vavien

510-01XX00-211

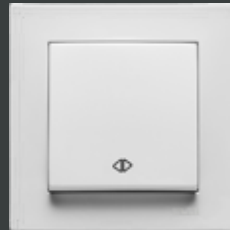
1 Gang 2 Way
Switch Intermediate
Ara Vavien (Permütatör)

510-01XX00-214

Blind Switch
Jaluzi Kumanda Anahtarı

510-01XX00-216

Double Pole Switch
Illuminated
İki Kutuplu Işıklı Anahtar

510-01XX00-236

3 Gang 1 Way Switch
Üçlü Anahtar

510-01XX00-254

2 Gang 1 Way
Control Switch Light
Komütatör Light

510-01XX00-257

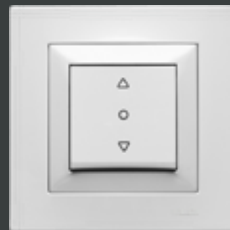
Blind Control Switch
(3 Position)
Tek Düğmeli Jaluzi
Anahtarı (3 Konumlu)

510-01XX00-297

Double Pole Switch
İki Kutuplu Anahtar

510-01XX00-269

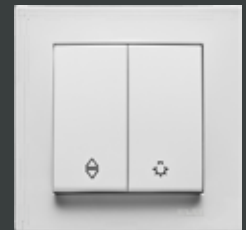
Vavien + Light Switch
Vavien + Light Anahtar

510-01XX00-281

■ Hızlı bağlantı seçimi için lütfen 01 yerine 03 yazınız. / For quick connection selection, please write 01 instead of 03.

* To select color of product please replace the XX with the color code: White 02, Cream 03, Snow White 56, Latte (Anthracite) 40, M. Grey 10, Fume 11, Titanium 14, Ivory 25, Vantablack 48, Maple 27, New Cherry 28, White Oak 42, Mahogany 29, Matt White 62, Matt Cream 65, Mat Fume 67.

* Ürün renklerini belirtmek için ürün kodundaki XX yerine; 02 Beyaz, 03 Krem, 56 Karbeyaz, 40 Latte (Antrasit), 10 M. Gri, 11 Füme, 14 Titanyum, 25 Fildişi, 48 Vantablack, 28 Yeni Kiraz, 42 Beyaz Meşe, 29 Maun, 27 Akçağaç, 62 Mat Beyaz, 65 Mat Krem, 67 Mat Füme gelecek şekilde sipariş verilmelidir.

Functions / Fonksiyonlar



3Gang 1Way Hvac Switch
3'lü Klima Anahtarı

510-01XX00-279

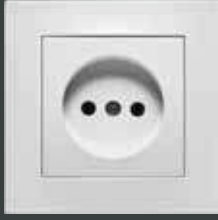

Socket Outlet Without Earthed Priz

510-01XX00-215

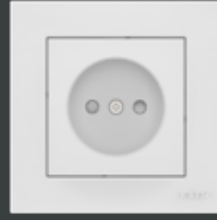

Child Protection Socket Outlet Without Earthed
Çocuk Korumalı Priz

510-01XX00-286



Socket Outlet Earthed
Topraklı Priz

510-01XX00-217



Socket Outlet Earthed With Hinged Lid
Kapaklı Topraklı Priz

510-01XX00-218



Socket Outlet Earthed Child Protection With Hinged Lid
Çocuk Korumalı Kapaklı Topraklı Priz

510-01XX00-219



Socket Outlet Earthed ChildProtection
Çocuk Korumalı Topraklı Priz

510-01XX00-243



Child Protection Ups Socket Outlet Earthed Pin
Çocuk Korumalı UPS Priz

510-01XX00-263

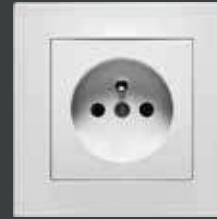

Ups Socket Outlet With Earthed Pin
UPS Priz

510-01XX00-268



Double USB Socket Outlet Earthed Child protection
İkili USB Topraklı Priz Çocuk Korumalı

510-01XX00-317



SAT Socket Outlet F Type
(RG 6 F Connector)
Uydu Prizi (RG 6 F Connector)

510-01XX00-180



TV Socket Outlet Through Line
TV Priz - Geçişli

510-01XX00-224



TV Socket Outlet End Of Line
TV Priz - Sonlu

510-01XX00-246



SAT Socket Outlet F Type Through Line
Uydu prizi geçişli (F dişi Konnektörlü)

510-01XX00-287



SAT Socket Outlet F Type End Of Line
Uydu prizi sonlu (F dişi Konnektörlü)

510-01XX00-288



Tv + SAT Socket Outlet Through Line
TV + SAT Prizi - Geçişli

510-01XX00-289



Tv + SAT Socket Outlet End Of Line
TV + SAT Prizi - Sonlu

510-01XX00-290



Shielded Tv Socket Outlet Without Resistance
TV Prizi Ekranlı - Dirençsiz

510-01XX00-274



Cable Outlet Cover
Kablo Çıkış Kapağı

510-01XX00-298



Shielded Tv Socket Outlet Through Line
TV Prizi Ekranlı-Geçişli

510-01XX00-272

■ Hızlı bağlantı seçimi için lütfen 01 yerine 03 yazınız. / For quick connection selection, please write 01 instead of 03.

* To select color of product please replace the XX with the color code: White 02, Cream 03, Snow White 56, Latte (Anthracite) 40, M. Grey 10, Fume 11, Titanium 14, Ivory 25, Vantablack 48, Maple 27, New Cherry 28, White Oak 42, Mahogany 29, Matt White 62, Matt Cream 65, Mat Fume 67.

* Ürün renklerini belirtmek için ürün kodundaki XX yerine; 02 Beyaz, 03 Krem, 56 Karbeyaz, 40 Latte (Antrasit), 10 M. Gri, 11 Füme, 14 Titanyum, 25 Fildişi, 48 Vantablack, 28 Yeni Kiraz, 42 Beyaz Meşe, 29 Maun, 27 Akçaağaç, 62 Mat Beyaz, 65 Mat Krem, 67 Mat Füme gelecek şekilde sipariş verilmelidir.

Functions / Fonksiyonlar



**Shielded Tv Socket Outlet
End Of Line**
TV Prizi Ekranlı-Sonlu

510-01XX00-273



SAT Socket Outlet F Type
Uydu Prizi
(F dişi Konnektörü)

510-01XX00-280



**Tv + Rad + SAT Socket
Outlet Through Line**
TV + Radyo + SAT-Geçişli

510-01XX00-233



**Tv + Rad + SAT Socket
Outlet End Of Line**
TV + Radyo + SAT - Sonlu

510-01XX00-234



VGA Socket
VGA Priz

510-01XX00-173



**Numeris Telephone
Socket Outlet** (RJ11 CAT3)
Nümeris Prizi (RJ11 CAT3)

510-01XX00-221



**Double Numeris Telephone
Socket Outlet** (2 x RJ11 CAT3)
İkili Nümeris Prizi
(2 x RJ11 CAT3)

510-01XX00-222



Data Socket Outlet
(RJ45 CAT6)
Data Prizi (RJ45 CAT6)

510-01XX00-247



Double Data Socket Outlet
(2 x RJ45 CAT6) İkili Data
Prizi (2 x RJ45 CAT6)

510-01XX00-248



USB Connector (Data Transfer)
USB Konnektör (Veri Transferi)

510-01XX00-242



**Data + Numeris Telephone
Socket Outlet** (RJ45 CAT6+
RJ11 CAT3) Data Prizi + Nümeris
Priz (RJ45 CAT6 + RJ11 CAT3)

510-01XX00-249



**Data + Numeris Telephone
Socket Outlet Without Jack**
Data Prizi + Nümeris Priz Jaksız

510-01XX00-260



**Numeris Socket
Without Jack**
Nümeris Prizi Jaksız

510-01XX00-282



Data Socket Without Jack
Data Prizi Jaksız

510-01XX00-296



Blind Cover
Kör Kapak

510-01XX00-299



Fiber Optic Data Socket
Fiber Optik Data Prizi

510-01XX00-300



**Double Fiber Optic
Data Socket**
İkili Fiber Optik Data Prizi

510-01XX00-304



Double USB Charger 5V 2,1A
USB Şarj Prizi 5V 2,1A Çiftli

510-01XX00-143



**Double USB Charging
Socket (Type C+A)**
USB Şarj Prizi (Type C+A) Çiftli

510-01XX00-335



HDMI Socket
HDMI Priz

500-01XX00-284

* To select color of product please replace the XX with the color code: White 02, Cream 03, Snow White 56, Latte (Anthracite) 40, M. Grey 10, Fume 11, Titanium 14, Ivory 25, Vantablack 48, Maple 27, New Cherry 28, White Oak 42, Mahogany 29, Matt White 62, Matt Cream 65, Mat Fume 67.

* Ürün renklerini belirtmek için ürün kodundaki XX yerine; 02 Beyaz, 03 Krem, 56 Karbeyaz, 40 Latte (Antrasit), 10 M. Gri, 11 Füme, 14 Titanyum, 25 Fildişi, 48 Vantablack, 28 Yeni Kiraz, 42 Beyaz Meşe, 29 Maun, 27 Akçağaç, 62 Mat Beyaz, 65 Mat Krem, 67 Mat Füme gelecek şekilde sipariş verilmelidir.

Functions / Fonksiyonlar



Double USB(Type C+A) Socket
Outlet Earthed Child protection
İkili USB(Type C+A) Topraklı Priz
Çocuk Korumalı

510-01XX00-334



Double USB Charging
HDMI Socket
İkili USB Şarj HDMI Prizi

510-01XX00-337



Relay Motion Sensor
Röleli Hareket Sensörü

510-01XX00-262



Triac Motion Sensor
Triyaklı Hareket Sensörü

510-01XX00-264



Dimmer 500W
Dimmer 500W

510-01XX00-212



Dimmer Illuminated (1000W)
Işıklı Dimmer (1000W)

510-01XX00-192



Dimmer (1000W)
Dimmer (1000W)

510-01XX00-112



1-10V Dimmer
1-10V Dimmer

510-01XX00-316



5-300W RC Dimmer
5-300W RC Dimmer

510-01XX00-310



220V Ventilator Control
Switch 200W
220V Fan Dimmer 200W

510-01XX00-278



RC Led dimmer 5-60W
RC Led dimmer 5-60W

510-01XX00-308



Rf Energy Saver
Rf Enerji Saver

510-01XX00-318



Rfid Energy Saver
Rfid Enerji Saver

510-01XX00-158



Mechanical Energy Saving
Suitable with Slim Card
İnce Kartlı Mekanik Enerji Saver

510-01XX00-319



Mechanical Energy Saver
Mekanik Enerji Saver

510-01XX00-266

IP44

An IP44 rating means that your product will be protected from solid particles that are over 1mm in size and from low velocity sprays of water from every direction.

IP44 derecesine sahip 1 ürün, 1mm'den büyük katı cisimlere ve her yönde sıçrayan suya karşı korumalıdır.

ELBİ *new*

IP44 1Gang 1Way Switch
IP44 Anahtar

510-08XX00-200



IP44 2Gang 1Way Switch
IP44 Komütatör

510-08XX00-202



IP44 Socket Outlet
Earthed With Hinged Lid
IP44 Kapaklı Topraklı Priz

510-08XX00-218



IP44 Socket Outlet Earthed
Child Protection With Hinged Lid
IP44 Çocuk Korumalı Kapaklı
Topraklı Priz

510-08XX00-219

* To select color of product please replace the XX with the color code: White 02, Cream 03, Snow White 56, Latte (Anthracite) 40, M. Grey 10, Fume 11, Titanium 14, Ivory 25, Vantablack 48, Maple 27, New Cherry 28, White Oak 42, Mahogany 29, Matt White 62, Matt Cream 65, Mat Fume 67.

* Ürün renklerini belirtmek için ürün kodundaki XX yerine; 02 Beyaz, 03 Krem, 56 Karbeyaz, 40 Latte (Antrasit), 10 M. Gri, 11 Füme, 14 Titanyum, 25 Fildişi, 48 Vantablack, 28 Yeni Kiraz, 42 Beyaz Meşe, 29 Maun, 27 Akçaağaç, 62 Mat Beyaz, 65 Mat Krem, 67 Mat Füme gelecek şekilde sipariş verilmelidir.

Gang Frames / Çoklu Çerçeveler



Single Frame / Tekli Çerçeve
510-01XX00-271



2 Gang Frame / İkili Çerçeve
510-01XX00-226

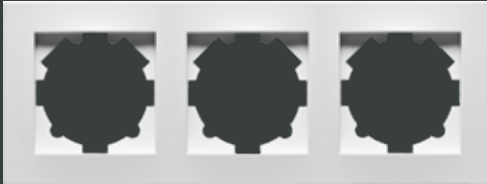

3 Gang Frame / Üçlü Çerçeve
510-01XX00-227



4 Gang Frame / Dörtlü Çerçeve
510-01XX00-228

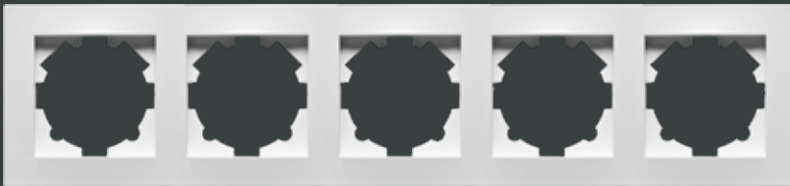

5 Gang Frame / Beşli Çerçeve
510-01XX00-250



6 Gang Frame / Altılı Çerçeve
510-01XX00-252



Red Child Prot Ups Socket
Outlet Earthed Pin M+C
Kırmızı Çocuk Korumalı
UPS Priz M+K

609-012600-263



Red Ups Socket Outlet
Earthed Pin M+C
Kırmızı UPS Priz M+K

609-012600-268



Double Socket Outlet Without Earthed
İkili Sıva Altı Priz

510-01XX30-908



Double Socket Outlet Earthed
İkili Sıva Altı Topraklı Priz

510-01XX30-907



Flush Mounted 3G Earthed Socket Outlet
Sıvaaltı Üçlü Topraklı Priz

500-00XX00-819

*only natural and silverline series.

*sadece natural ve silverline serlerimizdedir.

◆ Multiple frames can be used horizontally and vertically. / Çoklu çerçeveler yatay ve dikey olarak kullanılabilir.

■ Hızlı bağlantı seçimi için lütfen 01 yerine 03 yazınız. / For quick connection selection, please write 01 instead of 03.

* To select color of product please replace the XX with the color code: White 02, Cream 03, Snow White 56, Latte (Anthracite) 40, M. Grey 10, Fume 11, Titanium 14, Ivory 25, Vantablack 48, Maple 27, New Cherry 28, White Oak 42, Mahogany 29, Matt White 62, Matt Cream 65, Mat Fume 67.

* Ürün renklerini belirtmek için ürün kodundaki XX yerine; 02 Beyaz, 03 Krem, 56 Karbeyaz, 40 Latte (Antrasit), 10 M. Gri, 11 Füme, 14 Titanyum, 25 Fildişi, 48 Vantablack, 28 Yeni Kiraz, 42 Beyaz Meşe, 29 Maun, 27 Akçaağaç, 62 Mat Beyaz, 65 Mat Krem, 67 Mat Füme gelecek şekilde sipariş verilmelidir.

turn on the life

jazz

Experience the Energy with Jazz.

The rhythm and aesthetics of music are powerful elements that inspire our lives. Jazz Series Switch Sockets combine this inspiration with energy. With its curved structure and aesthetic appearance, it is ready to become the energy center of your home or workplace.

Enerjiyi Jazzla Yaşayın.

Müziğin ritmi ve estetiği, yaşamımıza ilham veren güçlü öğelerdir. Jazz Serisi Anahtar Prizler, bu ilhamı enerji ile birleştiriyor. Kavisli yapısı ve estetik görünümüyle, evinizin veya işyerinizin enerji merkezi olmaya hazır.

Color Options / Renk Seçenekleri

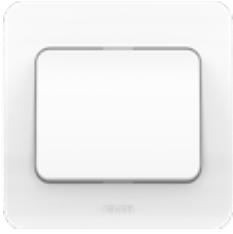
jazz natural

WHITE
BEYAZ
508-010200-200



CREAM
KREM
508-010300-200

jazz silverline

VANTABLACK
508-014800-200



TITANIUM
TİTANYUM
508-011400-200



BASALT
BAZALT
508-016100-200



SMOKE GREY
DUMAN GRİSİ
508-017400-200

jazz woodline

ANTIQUÉ WALNUT
ANTİK CEVİZ
508-010400-200



CHERRY
KIRAZ
508-010600-200



BEECH
KAYIN
508-010700-200

jazz pastel

MATT WHITE
MAT BEYAZ
508-016200-200



MATT CREAM
MAT KREM
508-016500-200



MATT FUME
MAT FÜME
508-016700-200

jazz

* To select color of product please replace the XX with the color code: White 02, Cream 03, Vantablack 48, Titanium 14, Smoke Grey 74, Basalt 61, Antique Walnut 04, Cherry 06, Beech 07, Matt White 62, Matt Cream 65, Mat Fume 67.

* Ürün renklerini belirtmek için ürün kodundaki XX yerine; 02 Beyaz, 03 Krem, 48 Vantablack, 14 Titanyum, 74 Duman Grisi, 61 Bazalt, 04 Antik Ceviz, 06 Kiraz, 07 Kayın, 62 Mat Beyaz, 65 Mat Krem, 67 Mat Füme gelecek şekilde sipariş verilmelidir.

Color Options / Renk Seçenekleri

Frame & Mechanism + Cover / Çerçeve & Mekanizma + Kapak

jazznatural

WHITE
BEYAZ
508-010200-271



CREAM
KREM
508-010300-271



WHITE
BEYAZ
607-010200-200



CREAM
KREM
607-010300-200

jazzsilverline

SMOKE GREY
DUMAN GRİSİ
508-017400-271



TITANIUM
TİTANYUM
508-011400-271



BASALT
BAZALT
508-016100-271



SMOKE GREY
DUMAN GRİSİ
607-017400-200



TITANIUM
TİTANYUM
607-011400-200



BASALT
BAZALT
607-016100-200



VANTABLACK
508-014800-271



VANTABLACK
607-014800-200

jazzwoodline

ANTIQUE WALNUT
ANTİK CEVİZ
508-010400-271



ANTIQUE WALNUT
ANTİK CEVİZ
607-010400-200



CHERRY
KIRAZ
508-010600-271



CHERRY
KIRAZ
607-010600-200



BEECH
KAYIN
508-010700-271



BEECH
KAYIN
607-010700-200

jazzpastel

MATT WHITE
MAT BEYAZ
508-016200-271



MATT CREAM
MAT KREM
508-016500-271



MATT FUME
MAT FÜME
508-016700-271



MATT WHITE
MAT BEYAZ
607-016200-200



MATT CREAM
MAT KREM
607-016500-200



MATT FUME
MAT FÜME
607-016700-200

Montage Schema / Montaj Şeması

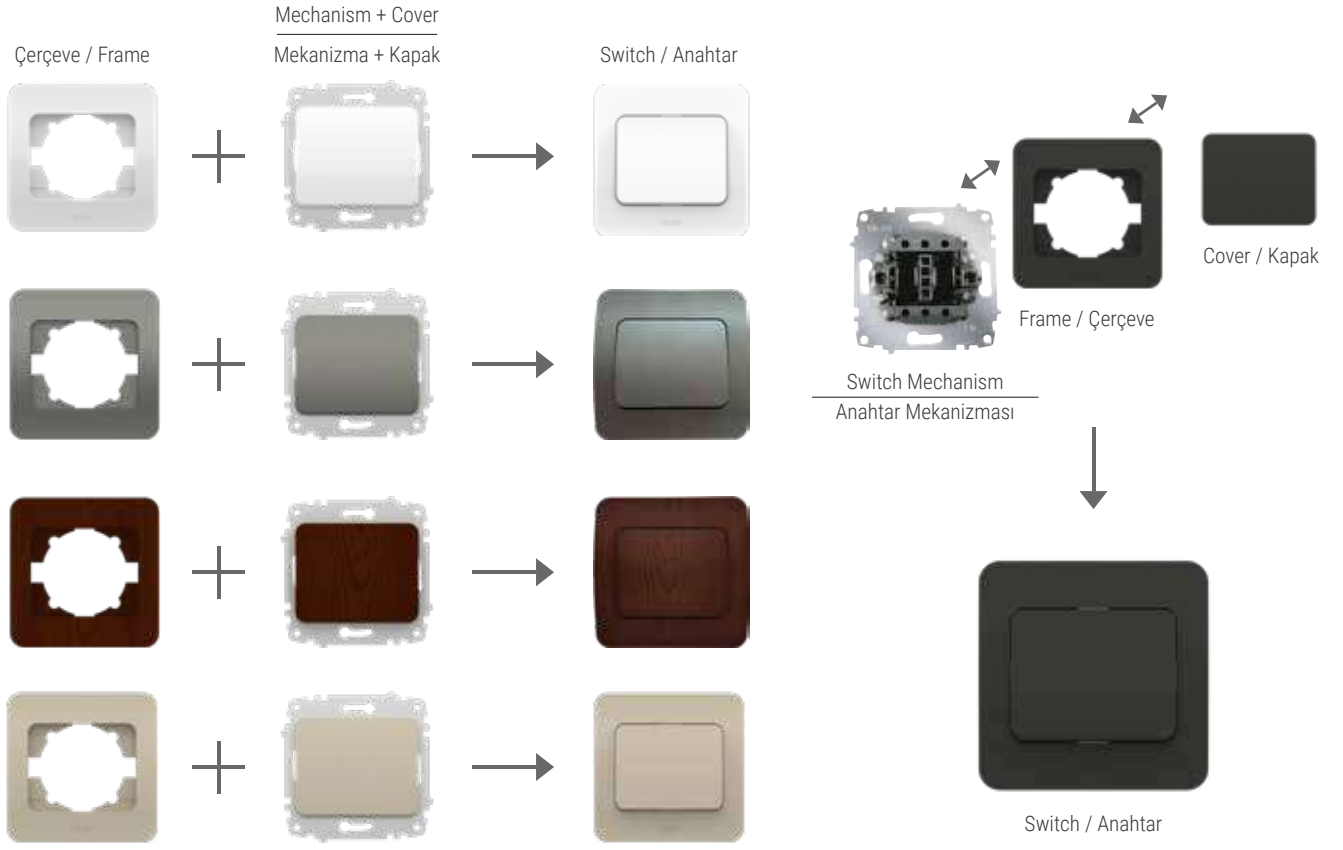

turn on the life

jazzfunctions

fonksiyonlar



ELBI

TELEFON

Functions / Fonksiyonlar



1Gang 1Way Switch
Anahtar

508-01XX00-200



1Gang 1Way Switch
Illuminated
Işıklı Anahtar

508-01XX00-201



2Gang 1Way Switch
Komütatör

508-01XX00-202



2Gang 1Way Switch
Illuminated
Işıklı Komütatör

508-01XX00-203



Control Switch Door
Kapı Otomatığı

508-01XX00-204



Control Switch Light
Light Anahtarı

508-01XX00-205



Control Switch
Illuminated Light
Işıklı Light Anahtar

508-01XX00-206



Control Switch Bell
Zil Anahtarı

508-01XX00-207



12V Illuminated Labelled
Control Switch Bell
12V Işıklı İsimli Zil

508-01XX00-208



1Gang 2Way Switch
Vavien

508-01XX00-209



1 Gang 2 Way
Switch Illuminated
Işıklı Vavien

508-01XX00-210



2 Gang 2 Way Switch
Komütatör Vavien

508-01XX00-211



1 Gang 2 Way
Switch Intermediate
Ara Vavien (Permütatör)

508-01XX00-214



Blind Switch
Jaluzi Kumanda Anahtarı

508-01XX00-216



Double Pole Switch
Illuminated
İki Kutuplu Işıklı Anahtar

508-01XX00-236



3 Gang 1 Way Switch
Üçlü Anahtar

508-01XX00-254



2 Gang 1 Way
Control Switch Light
Komütatör Light

508-01XX00-257



Double Pole Switch
İki Kutuplu Anahtar

508-01XX00-269



Vavien + Light Switch
Vavien + Light Anahtar

508-01XX00-281

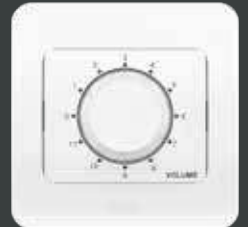

Music Volume Control Switch
Müzik Yayın Anahtarı

508-01XX00-261

* To select color of product please replace the XX with the color code: White 02, Cream 03, Vantablack 48, Titanium 14, Smoke Grey 74, Basalt 61, Antique Walnut 04, Cherry 06, Beech 07, Matt White 62, Matt Cream 65, Mat Fume 67.

* Ürün renklerini belirtmek için ürün kodundaki XX yerine; 02 Beyaz, 03 Krem, 48 Vantablack, 14 Titanyum, 74 Duman Grisi, 61 Bazalt, 04 Antik Ceviz, 06 Kiraz, 07 Kayın, 62 Mat Beyaz, 65 Mat Krem, 67 Mat Fume gelecek şekilde sipariş verilmelidir.

Functions / Fonksiyonlar



**SAT Socket Outlet F Type
(RG 6 F Connector)**
Uydu Prizi (RG 6 F Connector)

508-01XX00-180



**SAT Socket Outlet F Type
Through Line**
Uydu prizi geçişli
(F dişi Konnektörlü)

508-01XX00-287



**SAT Socket Outlet F Type
End Of Line**
Uydu prizi sonlu
(F dişi Konnektörlü)

508-01XX00-288



**Tv + SAT Socket Outlet
Through Line**
TV + SAT Prizi - Geçişli

508-01XX00-289



**Tv + SAT Socket Outlet
End Of Line**
TV + SAT Prizi - Sonlu

508-01XX00-290



**Socket Outlet
Without Earthed
Priz**

508-01XX00-215



**Socket Outlet
Earthed**
Topraklı Priz

508-01XX00-217



**Socket Outlet Earthed
With Hinged Lid**
Kapaklı Topraklı Priz

508-01XX00-218



**Socket Outlet Earthed
Child Protection**
Çocuk Korumalı Topraklı Priz

508-01XX00-243



**Socket Outlet Earthed Child
Protection With Hinged Lid**
Çocuk Korumalı Kapaklı
Topraklı Priz

508-01XX00-219



**Ups Socket Outlet
With Earthed Pin**
UPS Priz

508-01XX00-268



**Child Protection Ups
Socket Outlet Earthed Pin**
Çocuk Korumalı UPS Priz

508-01XX00-263



**Music Hi-Fi Socket
Outlet 2 Gang**
İkili Müzik Yayın Prizi

508-01XX00-241



USB Connector (Data Transfer)
USB Konnektör (Veri Transferi)

508-01XX00-242



**Numeris Telephone
Socket Outlet (RJ11 CAT3)**
Nümeris Prizi (RJ11 CAT3)

508-01XX00-221



**Double Numeris Telephone
Socket Outlet (2 x RJ11 CAT3)**
İkili Nümeris Prizi
(2 x RJ11 CAT3)

508-01XX00-222



**Data Socket Outlet
(RJ45 CAT6)**
Data Prizi (RJ45 CAT6)

508-01XX00-247



**Double Data Socket Outlet
(2 x RJ45 CAT6) İkili Data
Prizi (2 x RJ45 CAT6)**

508-01XX00-248



**Data + Numeris Telephone
Socket Outlet (RJ45 CAT6+
RJ11 CAT3) Data Prizi + Nümeris
Priz (RJ45 CAT6+RJ11 CAT3)**

508-01XX00-249



Fiber Optic Data Socket
Fiber Optik Data Prizi

508-01XX00-300

* To select color of product please replace the **XX** with the color code: White **02**, Cream **03**, Vantablack **48**, Titanium **14**, Smoke Grey **74**, Basalt **61**, Antique Walnut **04**, Cherry **06**, Beech **07**, Matt White **62**, Matt Cream **65**, Mat Fume **67**.

* Ürün renklerini belirtmek için ürün kodundaki **XX** yerine; **02** Beyaz, **03** Krem, **48** Vantablack, **14** Titanyum, **74** Duman Grisi, **61** Bazalt, **04** Antik Ceviz, **06** Kiraz, **07** Kayın, **62** Mat Beyaz, **65** Mat Krem, **67** Mat Fume gelecek şekilde sipariş verilmelidir.

Functions / Fonksiyonlar



Double Fiber Optic
Data Socket
İkili Fiber Optik Data Prizi

508-01XX00-304



HDMI Socket
HDMI Priz

508-01XX00-284



Double HDMI Socket
İkili HDMI Priz

508-01XX00-336



HDMI + USB Socket
HDMI + USB Priz

508-01XX00-337



Data + Numeris Telephone
Socket Outlet Without Jack
Data Prizi + Nümeris Priz Jaksız

510-01XX00-260



Data Socket Without Jack
Data Prizi Jaksız

508-01XX00-296



Cable Outlet Cover
Kablo Çıkış Kapağı

508-01XX00-298



Dimmer (1000W)
Dimmer (1000W)

508-01XX00-112



Dimmer Illuminated (1000W)
Işıklı Dimmer (1000W)

508-01XX00-192



RC Led dimmer 5-60W
RC Led dimmer 5-60W

508-01XX00-308



5-300W RC Dimmer
5-300W RC Dimmer

508-01XX00-310



1-10V Dimmer
1-10V Dimmer

508-01XX00-316



Tv + Rad + SAT Socket
Outlet End Of Line
TV + Radyo + SAT - Sonlu

508-01XX00-234



TV Socket Outlet
Through Line
TV Priz - Geçişli

508-01XX00-224



Shielded Tv Socket Outlet
Through Line
TV Prizi Ekranlı-Geçişli

508-01XX00-272



3Gang 1Way Hvac Switch
3'lü Klima Anahtarı

508-01XX00-279



220V Ventilator Control
Switch 200W
220V Fan Dimmer 200W

508-01XX00-278



Air Conditioner
Switch 25A
25A Klima Anahtarı

508-01XX00-275



TV Socket- without card
Tv Priz - Kartsız

508-00XX00-270



British Type Socket
Outlet Earthed
İngiliz Tipi Topraklı Priz

508-01XX00-294

* To select color of product please replace the XX with the color code: White 02, Cream 03, Vantablack 48, Titanium 14, Smoke Grey 74, Basalt 61, Antique Walnut 04, Cherry 06, Beech 07, Matt White 62, Matt Cream 65, Mat Fume 67.

* Ürün renklerini belirtmek için ürün kodundaki XX yerine; 02 Beyaz, 03 Krem, 48 Vantablack, 14 Titanyum, 74 Duman Grisi, 61 Bazalt, 04 Antik Ceviz, 06 Kiraz, 07 Kayın, 62 Mat Beyaz, 65 Mat Krem, 67 Mat Fume gelecek şekilde sipariş verilmelidir.

Functions / Fonksiyonlar



**TV + Radio Socket Outlet
Through Line**
Tv-Radyo Prizi-Geçişli

508-00XX00-220



Telephone Socket Outlet
Telefon Priz

508-00XX00-223



Data Socket Cat5
Data Prizi Cat5

508-00XX00-229



Music Hi Fi Socket Outlet
Müzik Yayın Prizi

508-00XX00-235



Energy Saver
Enerji Saver

508-00XX00-267



Energy Saver Optic
Energy Saver Optik Algılamalı

510-00XX00-258



Rfid Energy Saver
Rfid Enerji Saver

508-01XX00-158



Rf Energy Saver
Rf Enerji Saver

508-01XX00-318



Double UPS Socket Outlet
İkili Sıva Altı UPS Priz

508-01XX30-906



Double Socket Outlet Earthed
İkili Sıva Altı Topraklı Priz

508-01XX30-907



Double Socket Outlet Without Earthed
İkili Sıva Altı Priz

508-01XX30-908



**Child Protection Double
UPS Socket Outlet**
Çocuk Korumalı İkili Sıva Altı UPS Priz

508-01XX00-916



**Child Protection Double
Socket Outlet Earthed**
Çocuk Korumalı İkili Sıva Altı Topraklı Priz

508-01XX00-917



**Child Protection Double
Socket Outlet Without Earthed**
Çocuk Korumalı İkili Sıva Altı Priz

508-01XX00-918

* To select color of product please replace the **XX** with the color code: White **02**, Cream **03**, Black **30**, Snow White **56**, Latte (Anthracite) **40**, M. Grey **10**, Fume **11**, Titanium **14**, Ivory **25**, Vantablack **48**, Maple **27**, New Cherry **28**, White Oak **42**, Mahogany **29**.

* Ürün renklerini belirtmek için ürün kodundaki **XX** yerine; **02** Beyaz, **03** Krem, **30** Siyah, **56** Karbeyaz, **40** Latte (Antrasit), **10** M. Gri, **11** Füme, **14** Titanyum, **25** Fildişi, **48** Vantablack, **28** Yeni Kiraz, **42** Beyaz Meşe, **29** Maun, **27** Akçaağaç gelecek şekilde sipariş verilmelidir.

Gang Frames / Çoklu Çerçevesler



Single Frame / Tekli Çerçeve
508-01XX00-271

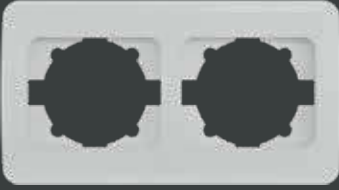

2 Gang Frame / İkili Çerçeve
508-01XX00-226



3 Gang Frame / Üçlü Çerçeve
508-01XX00-227



4 Gang Frame / Dörtlü Çerçeve
508-01XX00-228



5 Gang Frame / Beşli Çerçeve
508-01XX00-250



6 Gang Frame / Altılı Çerçeve
508-01XX00-252

* To select color of product please replace the XX with the color code: White 02, Cream 03, Vantablack 48, Titanium 14, Smoke Grey 74, Basalt 61, Antique Walnut 04, Cherry 06, Beech 07, Matt White 62, Matt Cream 65, Mat Fume 67.

* Ürün renklerini belirtmek için ürün kodundaki XX yerine; 02 Beyaz, 03 Krem, 48 Vantablack, 14 Titanyum, 74 Duman Grisi, 61 Bazalt, 04 Antik Ceviz, 06 Kiraz, 07 Kayın, 62 Mat Beyaz, 65 Mat Krem, 67 Mat Füme gelecek şekilde sipariş verilmelidir.

turn on the life

zirve

Crown spaces with simplicity.

The distinctive design of Zirve Natural which is inspired for simplicity is ideal for living spaces.

Mekanları sadelikle taçlandırın.

Zirve Natural'ın sadelikten ilham alan farklı tasarımı, yaşam alanları için ideal.



zirvefixline



zirvefixline
WHITE / BEYAZ
501-010201-200



zirvefixline
CREAM / KREM
501-010301-200

zirvenatural



zirvenatural
WHITE / BEYAZ
501-010210-200



zirvenatural
CREAM / KREM
501-010310-200



zirvefixline
ANTIQUÉ WALNUT
ANTİK CEVİZ
501-010401-200



zirvefixline
CHERRY
KIRAZ
501-010601-200



zirvefixline
BEECH
KAYIN
501-010701-200



zirvefixline
NEW OAK
YENİ MEŞE
501-010801-200



zirvefixline
METALLIC GREY
METALİK GRİ
501-011001-200

Cordon Colors / Kordon Renkleri



CORDONS / KORDONLAR

Product Code Ürün Kodu	Product Name Ürün Adı	Units Per Box Kutudaki Adet	Units Per Package Kolidaki Adet
601-000110-706	Metallic Grey Cordon / Metalik Gri Kordon	200	1200
601-000128-706	Gold Cordon / Altın Kordon	200	1200
601-000121-706	Chrome Cordon / Krom Kordon	200	1200
601-000102-706	White Cordon / Beyaz Kordon	200	1200
601-000103-706	Cream Cordon / Krem Kordon	200	1200
601-000115-706	Grey Cordon / Gri Kordon	200	1200
601-000104-706	Antique Walnut Cordon / Antik Ceviz Kordon	200	1200
601-000107-706	Beech Cordon / Kayın Kordon	200	1200
601-000108-706	New Oak Cordon / Yeni Meşe Kordon	200	1200
601-000106-706	Cherry Cordon / Kiraz Kordon	200	1200
601-000117-706	Claret Cordon / Bordo Kordon	200	1200
601-000118-706	Light Green Cordon / Açık Yeşil Kordon	200	1200
601-000120-706	Brown Cordon / Kahverengi Kordon	200	1200
601-000122-706	Dark Blue Cordon / Lacivert Kordon	200	1200
601-000123-706	Blue Cordon / Mavi Kordon	200	1200
		200	1200

Gang Frames / Çoklu Çerçevesler



Zirve 1 Gang Frame
Zirve Tekli Çerçeve
507-00XX0Y-271



Zirve / Tuna Surface Case
Zirve / Tuna Sivaüstü Kasa
501-00XX00-253

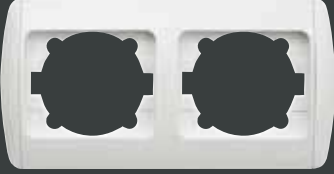

Zirve 2 Gang Frame Horizontal
Zirve 2'li Yatay Çerçeve
501-00XX0Y-226



Zirve 3 Gang Frame Horizontal
Zirve 3'lü Yatay Çerçeve
501-00XX0Y-227

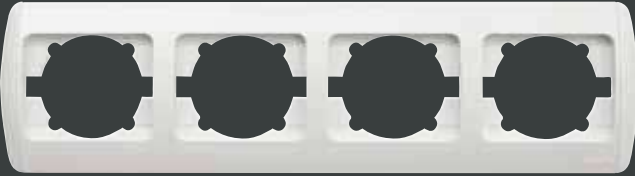

Zirve 4 Gang Frame Horizontal
Zirve 4'lü Yatay Çerçeve
501-00XX0Y-228



Zirve 5 Gang Frame Horizontal
Zirve 5'li Yatay Çerçeve
501-00XX0Y-250



Zirve 6 Gang Frame Horizontal
Zirve 6'lı Yatay Çerçeve
501-00XX0Y-252

* To select color of product please replace the Y with the code: without cordon 0, fixline 1, white cordon 2, cream cordon 3.

* To select color of product please replace the XX with the color code: White 02, Cream 03, M. Grey 10, Antique Walnut 04, Cherry 06, Beech 07, New Oak 08.

* Ürün renklerini belirtmek için ürün kodundaki Y yerine; 0 Kordonsuz, 1 Fixline, 2 Beyaz Kordonlu, 3 Krem Kordonlu.

* Ürün renklerini belirtmek için ürün kodundaki XX yerine; 02 Beyaz, 03 Krem, 10 M. Gri, 04 Antik Ceviz, 06 Kiraz, 07 Kayın, 08 Yeni Meşe gelecek şekilde sipariş verilmelidir.

Gang Frames / Çoklu Çerçeveler



Zirve 1 Gang Frame
Zirve Tekli Çerçeve
507-00XX0Y-271

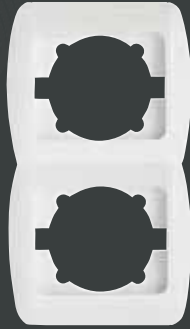

Zirve 2 Gang Frame
Vertical
Zirve 2'li Dikey
Çerçeve
501-00XX0Y-238



Zirve 3 Gang Frame
Vertical
Zirve 3'lü Dikey
Çerçeve
501-00XX0Y-239



Zirve 4 Gang Frame
Vertical
Zirve 4'lü Dikey
Çerçeve
501-00XX0Y-240



Zirve 5 Gang Frame
Vertical
Zirve 5'li Dikey
Çerçeve
501-00XX0Y-251



Y = 0
Without Cordon
Kordonsuz



Y = 1
Fixline



Y = 2
White Cordon
Beyaz Kordon



Y = 3
Krem Kordon
Cream Cordon

* To select color of product please replace the **Y** with the code: without cordon 0, fixline 1, white cordon 2, cream cordon 3.

* To select color of product please replace the **XX** with the color code: White 02, Cream 03, M. Grey 10, Antique Walnut 04, Cherry 06, Beech 07, New Oak 08.

* Ürün renklerini belirtmek için ürün kodundaki **Y** yerine; 0 Kordonsuz, 1 Fixline, 2 Beyaz Kordonlu, 3 Krem Kordonlu.

* Ürün renklerini belirtmek için ürün kodundaki **XX** yerine; 02 Beyaz, 03 Krem, 30 Siyah, 10 M. Gri, 04 Antik Ceviz, 06 Kiraz, 07 Kayın, 08 Yeni Meşe gelecek şekilde sipariş verilmelidir.

Montage Schema / Montaj Şeması

zirve natural*zirve fixline*

turn on the life

zirvefunctions

fonksiyonlar



ELBI
ELECTRIC

Functions / Fonksiyonlar



1Gang 1Way Switch
Anahtar

501-01XX0Y-200



1Gang 1Way Switch Illuminated
Işıklı Anahtar

501-01XX0Y-201



2Gang 1Way Switch
Komütatör

501-01XX0Y-202



2Gang 1Way Switch Illuminated
Işıklı Komütatör

501-01XX0Y-203



Control Switch Door
Kapı Otomatığı

501-01XX0Y-204



Control Switch Light
Light Anahtarı

501-01XX0Y-205



Control Switch Illuminated Light
Işıklı Light Anahtarı

501-01XX0Y-206



Control Switch Bell
Zil Anahtarı

501-01XX0Y-207



Labelled Switch Bell
İsimli Zil Anahtarı

501-01XX0Y-208



1Gang 2Way Switch
Vavien

501-01XX0Y-209



1Gang 2Way Switch Illuminated
Işıklı Vavien

501-01XX0Y-210



2Gang 2Way Switch
Komütatör Vavien

501-01XX0Y-211



1Gang 2Way Switch Intermediate
Ara Vavien (Permütatör)

501-01XX0Y-214



Socket Outlet Without Earthed
Priz

501-01XX0Y-215



Blind Switch
Jaluzi Kumanda Anahtarı

501-01XX0Y-216



Socket Outlet Earthed
Topraklı Priz

501-01XX0Y-217



Socket Outlet With Hinged Lid
Kapaklı Topraklı Priz

501-01XX0Y-218



Double Pole Switch Illuminated
İki Kutuplu Işıklı Anahtar

501-01XX0Y-236



Socket Outlet Earthed Child Protection
Çocuk Korumalı Topraklı Priz

501-01XX0Y-243



3 Gang 1Way Switch
Üçlü Anahtar

501-01XX0Y-254

* To select color of product please replace the Y with the code: without cordon 0, fixline 1, white cordon 2, cream cordon 3.

* To select color of product please replace the XX with the color code: White 02, Cream 03, M. Grey 10, Antique Walnut 04, Cherry 06, Beech 07, New Oak 08.

* Ürün renklerini belirtmek için ürün kodundaki Y yerine; 0 Kordonsuz, 1 Fixline, 2 Beyaz Kordonlu, 3 Krem Kordonlu.

* Ürün renklerini belirtmek için ürün kodundaki XX yerine; 02 Beyaz, 03 Krem, 10 Siyah, 10 M. Gri, 04 Antik Ceviz, 06 Kiraz, 07 Kayın, 08 Yeni Meşe gelecek şekilde sipariş verilmelidir.

Functions / Fonksiyonlar



**Child Protection Ups
Socket Outlet With Earth Pin**
Çocuk Korunmalı UPS priz

501-01XX0Y-263



**Ups Socket Outlet
With Earth Pin**
UPS Priz

501-01XX0Y-268



Double Pole Switch
İki Kutuplu Anahtar

501-01XX0Y-269



**1Gang 2Way Switch +
Control Switch Light**
Veavien + Light Anahtarı

501-01XX0Y-281



**Child Protection Socket
Outlet Without Earthed**
Çocuk Korunmalı Priz

501-01XX0Y-286



Dimmer 1000W
Dimmer 1000W

501-00XX0Y-112



Dimmer 500W CE
Dimmer 500W CE

501-00XX0Y-144



SAT Socket Outlet
(RG6 F Connector)
Uydu Priz - (RG6 F KONNEKTÖR)

501-00XX00-180



Dimmer 300W CE
Dimmer 300W CE

501-00XX0Y-212



**TV + Radio Socket Outlet
Through Line**
TV + Rad - Geçişli

501-00XX0Y-220



**Numeris Telephone
Socket Outlet**
Nümeris Priz

501-00XX0Y-221



**Double Numeris Telephone
Socket Outlet**
İkili Nümeris Priz

501-00XX0Y-222



**TV Socket Outlet
Through Line**
TV Priz - Geçişli

501-00XX0Y-224



**TV + Radio Socket Outlet
End Of Line**
TV + Rad - Sonlu

501-00XX0Y-225



**Tv Socket Outlet Without
Resistance**
Tv Prizi - Dirençsiz

501-00XX0Y-232



**TV + RAD + SAT Socket
Outlet Through Line**
TV + RAD + SAT Priz - Geçişli

501-00XX0Y-233



**TV + RAD + SAT
Socket Outlet End Of Line**
TV + RAD + SAT - Sonlu

501-00XX0Y-234



**Music Hi Fi
Socket Outlet 1Gang**
Müzik Yayın Prizi

501-00XX0Y-235



**Music Hi Fi
Socket Outlet 2Gang**
2'li Müzik Yayın Prizi

501-00XX0Y-241



**220V Ventilator
Control Switch 200W**
Üçlü Klima Anahtarı

501-00XX0Y-279

* To select color of product please replace the Y with the code: without cordon 0, fixline 1, white cordon 2, cream cordon 3.

* To select color of product please replace the XX with the color code: White 02, Cream 03, M. Grey 10, Antique Walnut 04, Cherry 06, Beech 07, New Oak 08.

* Ürün renklerini belirtmek için ürün kodundaki Y yerine; 0 Kordonsuz, 1 Fixline, 2 Beyaz Kordonlu, 3 Krem Kordonlu.

* Ürün renklerini belirtmek için ürün kodundaki XX yerine; 02 Beyaz, 03 Krem, 10 Siyah, 10 M. Gri, 04 Antik Ceviz, 06 Kiraz, 07 Kayın, 08 Yeni Meşe gelecek şekilde sipariş verilmelidir.

Functions / Fonksiyonlar



**Tv Socket Outlet
End Of Line
TV Priz - Sonlu**

501-00XX0Y-246



**Data Socket Outlet (CAT6)
Data Priz (CAT6)**

501-00XX0Y-247



**Double Data
Socket Outlet (CAT6)
2'li Data Prizi (CAT6)**

501-00XX0Y-248



**Data + Numeris Telephone
Socket Outlet (CAT6) / Data +
Nümeris Telefon Prizi (CAT6)**

501-00XX0Y-249



**Data + Numeris Telephone
Socket Outlet Without Jac
Data + Nümeris Telefon
Prizi Jaksız**

501-00XX0Y-260



**Shielded Tv
Socket Outlet End Of Line
TV Priz Ekranlı Sonlu**

501-00XX0Y-273



**Shielded TV Socket Outlet
Without Resistance
TV Priz Ekranlı - Dirençsiz**

501-00XX0Y-274



**Shielded Tv Socket Outlet
Through Line
TV Priz Ekranlı - Geçişli**

501-00XX0Y-272



**TV + SAT Socket Outlet
Through Line
TV + SAT Prizi - Geçişli**

501-00XX0Y-289



**TV + SAT
Socket Outlet End Of Line
TV + SAT - Sonlu**

501-00XX0Y-290



**SAT Socket Outlet F Type
Uydu Priz - F Dişi Tipi**

501-00XX0Y-280



**SAT Socket Outlet F Type
Through Line
Uydu Priz - F Dişi Tipi - Geçişli**

501-01XX0Y-287



**SAT Socket Outlet F Type
End Of Line
Uydu Priz - F Dişi Tipi - Sonlu**

501-01XX0Y-288



**Cable Outlet Cover
Kablo Çıkış Kapağı**

501-00XX0Y-298



**Energy Saver Delayed
Optik Algılamalı Enerji
Saver Gecikmeli**

501-00XX0Y-258



**Energy Saver Delaye Without
Relay / Enerji Saver Özel
Logolu Gecikmeli**

501-00XX0Y-259



**Energy Saver + Keyholder
Enerji Saver + Anahtarlık**

501-00XX0Y-267



**Child Protection Socket
Outlet With Hinged Lid
Çocuk Korumalı
Kapaklı Topraklı Priz**

501-01XX0Y-219

* To select color of product please replace the Y with the code: without cordon 0, fixline 1, white cordon 2, cream cordon 3.

* To select color of product please replace the XX with the color code: White 02, Cream 03, M. Grey 10, Antique Walnut 04, Cherry 06, Beech 07, New Oak 08.

* Ürün renklerini belirtmek için ürün kodundaki Y yerine; 0 Kordonsuz, 1 Fixline, 2 Beyaz Kordonlu, 3 Krem Kordonlu.

* Ürün renklerini belirtmek için ürün kodundaki XX yerine; 02 Beyaz, 03 Krem, 10 Siyah, 10 M. Gri, 04 Antik Ceviz, 06 Kiraz, 07 Kayın, 08 Yeni Meşe gelecek şekilde sipariş verilmelidir.

Functions / Fonksiyonlar



**220V Ventilator
Control Switch 200W**
220V - 200W Fan Dimmer

501-00XX0Y-278



**Dimmer 500W CE With
Filter**
Dimmer 500W CE Filtreli

501-00XX0Y-244



**Music Volume
Control Switch**
Müzik Yayın Anahtarı

501-00XX0Y-261



**Air Conditioner
Switch 25A**
25A Klima Anahtarı

501-00XX0Y-275



Heater Switch 20 A
20 A Isıtıcı Anahtar

501-00XX0Y-276



**Double Socket Outlet Without
Earthed**
2'li UPS Priz

501-01XX0Y-906



Double Socket Outlet Earthed
2'li Sıva Altı Topraklı Priz

501-01XX0Y-907



**Double Socket Outlet with
Chiled Protected**
Çocuk Korumalı 2'li UPS Priz

501-01XX0Y-916



**Double Socket Outlet Earthed with
Chiled Protected**
Çocuk Korumalı 2'li Sıva Altı
Topraklı Priz

501-01XX0Y-917



**Double Socket Outlet with
Chiled Protected**
Çocuk Korumalı 2'li Sıva Altı Priz

501-01XX0Y-918



**Double Socket Outlet
Without Earthed**
2'li Sıva Altı Priz

501-01XX0Y-908

* To select color of product please replace the Y with the code: without cordon 0, fixline 1, white cordon 2, cream cordon 3.

* To select color of product please replace the XX with the color code: White 02, Cream 03, M. Grey 10, Antique Walnut 04, Cherry 06, Beech 07, New Oak 08.

* Ürün renklerini belirtmek için ürün kodundaki Y yerine; 0 Kordonsuz, 1 Fixline, 2 Beyaz Kordonlu, 3 Krem Kordonlu.

* Ürün renklerini belirtmek için ürün kodundaki XX yerine; 02 Beyaz, 03 Krem, 10 Siyah, 10 M. Gri, 04 Antik Ceviz, 06 Kiraz, 07 Kayın, 08 Yeni Meşe gelecek şekilde sipariş verilmelidir.

turn on the life

tuna

Pure happiness...

It's now easier to harmonize the places with the border options of Tuna

Duru bir mutluluk...

Tuna'nın bordür seçenekleri ile mekanlara uyum sağlamak şimdi çok kolay.

ELBI
ELECTRIC



Tuna
White / Beyaz
502-010202-200



Tuna
Cream / Krem
502-010303-200



Tuna
Grey / Gri
502-011515-200



Tuna
Matt Gold / Mat Altın
502-011313-200



Tuna
Fume / Füme
502-011111-200

Cordon Colors / Kordon Renkleri

CORDONS / KORDONLAR

Product Code Ürün Kodu	Product Name Ürün Adı	Units Per Box Kutudaki Adet	Units Per Package Koliadaki Adet
602-000104-706	Antique Walnut / Antik Ceviz	200	1200
602-000106-706	Cherry / Kiraz	200	1200
602-000108-706	New Oak / Yeni Meşe	200	1200
602-000117-706	Claret Red / Bordo	200	1200
602-000118-706	Light Green / Açık Yeşil	200	1200
602-000120-706	Brown / Kahverengi	200	1200
602-000122-706	Dark Blue / Lacivert	200	1200
602-000123-706	Blue / Mavi	200	1200
602-000124-706	Pink / Pembe	200	1200
602-000125-706	Yellow / Sarı	200	1200
602-000126-706	Orange / Turuncu	200	1200
602-000127-706	Green / Yeşil	200	1200
602-000110-706	Metallic Grey / Metalik Gri	200	1200
602-000111-706	Fume / Füme	200	1200
602-000113-706	Matte Gold / Mat Altın	200	1200
602-000119-706	Chrome / Krom	200	1200
602-000128-706	Gold / Altın	200	1200
602-000109-706	Black / Siyah	200	1200
602-000115-706	Tuna Grey / Tuna Gri	200	1200
602-000102-706	White / Beyaz	200	1200



Gang Frames / Çoklu Çerçevesler



Tuna 1 Gang Frame
Tuna Tekli Çerçeve
502-00XX0Y-271



Zirve / Tuna Surface Case
Zirve / Tuna Sıvaüstü Kasa
501-00XX00-253



Tuna 2 Gang Frame Horizontal
Tuna 2'li Yatay Çerçeve
502-00XX0Y-226

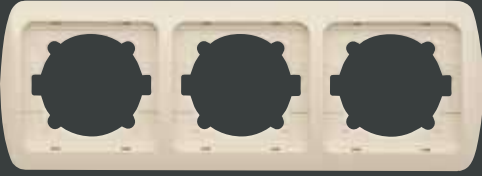

Tuna 3 Gang Frame Horizontal
Tuna 3'lü Yatay Çerçeve
502-00XX0Y-227

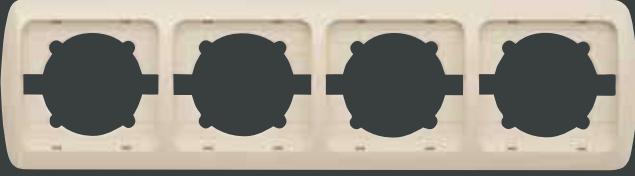

Tuna 4 Gang Frame Horizontal
Tuna 4'lü Yatay Çerçeve
502-00XX0Y-228



Tuna 5 Gang Frame Horizontal
Tuna 5'li Yatay Çerçeve
502-00XX0Y-250

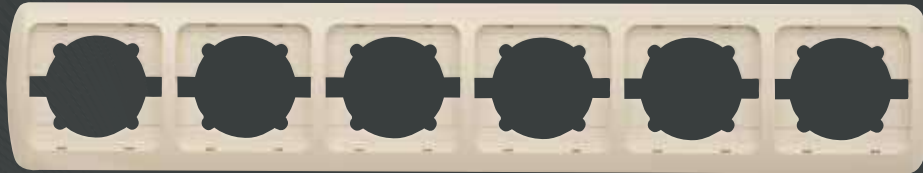

Tuna 6 Gang Frame Horizontal
Tuna 6'lı Yatay Çerçeve
502-00XX0Y-252

* To select color of product please replace the Y with the code: Without Cordon 0, Fixline 1, White Cordon 2, Cream Cordon 3.

* To select color of product please replace the XX with the color code: White 02, Cream 03, Grey 15, Matt Gold 13, Fume 11.

*Ürün renklerini belirtmek için ürün kodundaki Y yerine; 0 Kordonsuz, 1 Fixline, 2 Beyaz Kordonlu, 3 Krem Kordonlu.

*Ürün renklerini belirtmek için ürün kodundaki XX yerine; 02 Beyaz, 03 Krem, 15 Gri, 13 Mat Altın, 11 Füme gelecek şekilde sipariş verilmelidir.

Gang Frames / Çoklu Çerçevesler



Tuna 1 Gang Frame
Tuna Tekli Çerçeve
502-00XX0Y-271



Tuna 2 Gang Frame Vertical
Tuna 2'li Dikey Çerçeve
502-00XX0Y-238



Tuna 3 Gang Frame Vertical
Tuna 3'lü Dikey Çerçeve
502-00XX0Y-239



Tuna 4 Gang Frame Vertical
Tuna 4'lü Dikey Çerçeve
502-00XX0Y-240



Tuna 5 Gang Frame Vertical
Tuna 5'li Dikey Çerçeve
502-00XX0Y-251



Y = 0
Without Cordon
Kordonsuz



Y = 1
Fixline



Y = 2
White Cordon
Beyaz Kordon



Y = 3
Krem Kordon
Cream Cordon

* To select color of product please replace the Y with the code: Without Cordon 0, Fixline 1, White Cordon 2, Cream Cordon 3.

* To select color of product please replace the XX with the color code: White 02, Cream 03, Grey 15, Matt Gold 13, Fume 11.

*Ürün renklerini belirtmek için ürün kodundaki Y yerine; 0 Kordonsuz, 1 Fixline, 2 Beyaz Kordonlu, 3 Krem Kordonlu.

*Ürün renklerini belirtmek için ürün kodundaki XX yerine; 02 Beyaz, 03 Krem, 15 Gri, 13 Mat Altın, 11 Füme gelecek şekilde sipariş verilmelidir.

Montage Schema / Montaj Şeması

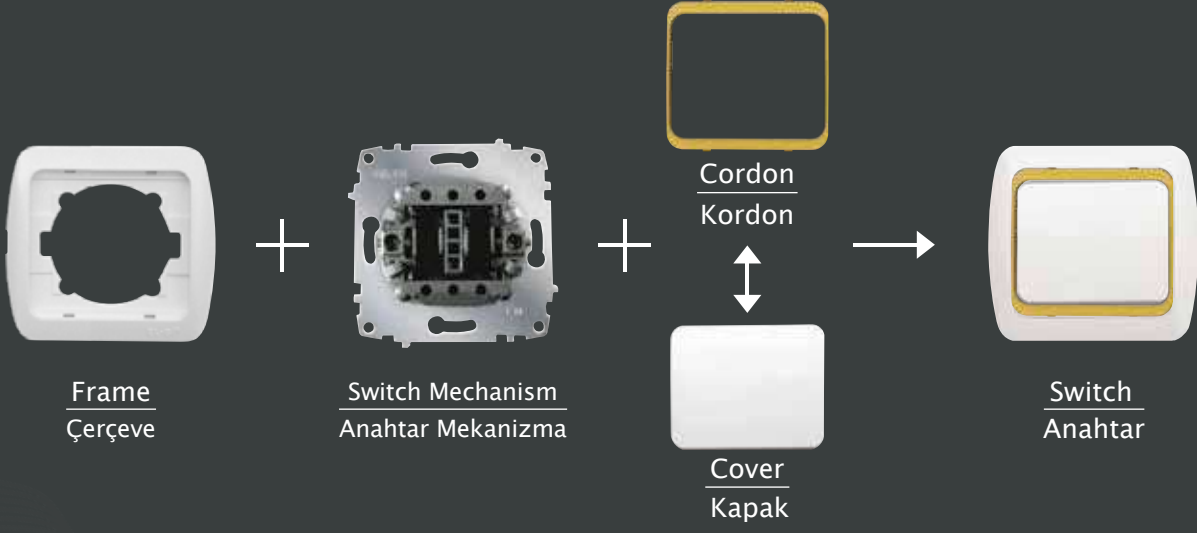

turn on the life

*tuna*functions

fonksiyonlar



ELBI
ELECTRIC

Functions / Fonksiyonlar



1Gang 1Way Switch
Anahtar

502-01XX0Y-200



1Gang 1Way Switch Illuminated
Işıklı anahtar

502-01XX0Y-201



2Gang 1Way Switch
Komütatör

502-01XX0Y-202



2Gang 1Way Switch Illuminated
Işıklı komütatör

502-01XX0Y-203



Control Switch Door
Kapı Otomatığı

502-01XX0Y-204



Control Switch Light
Light Anahtarı

502-01XX0Y-205



Control Switch Illuminated Light
Işıklı Light Anahtarı

502-01XX0Y-206



Control Switch Bell
Zil Anahtarı

502-01XX0Y-207



Labelled Switch Bell
İsimli Zil Anahtarı

502-01XX0Y-208



1Gang 2Way Switch
Vavien

502-01XX0Y-209



1Gang 2Way Switch Illuminated
Işıklı Vavien

502-01XX0Y-210



2Gang 2Way Switch
Komutator Vavien

502-01XX0Y-211



1Gang 2Way Switch Intermediate
Ara Vavien (Permütatör)

502-01XX0Y-214



Socket Outlet Without Earthed
Priz

502-01XX0Y-215



Blind Switch
Jaluzi Kumanda Anahtarı

502-01XX0Y-216



Socket Outlet Earthed
Topraklı Priz

502-01XX0Y-217



Socket Outlet With Hinged Lid
Kapaklı Topraklı Priz

502-01XX0Y-218



Double Pole Switch Illuminated
İki Kutuplu Işıklı Anahtar

502-01XX0Y-236



Socket Outlet Earthed Childprotection
Çocuk Korunmalı Topraklı Priz

502-01XX0Y-243



3 Gang 1 Way Switch
Üçlü Anahtar

502-01XX0Y-254

* To select color of product please replace the Y with the code: Without Cordon 0, Fixline 1, White Cordon 2, Cream Cordon 3.

* To select color of product please replace the XX with the color code: White 02, Cream 03, Grey 15, Matt Gold 13, Fume 11.

*Ürün renklerini belirtmek için ürün kodundaki Y yerine; 0 Kordonsuz, 1 Fixline, 2 Beyaz Kordonlu, 3 Krem Kordonlu.

*Ürün renklerini belirtmek için ürün kodundaki XX yerine; 02 Beyaz, 03 Krem, 15 Gri, 13 Mat Altın, 11 Füme gelecek şekilde sipariş verilmelidir.

Functions / Fonksiyonlar



Child Protection Ups Socket Outlet With Earth Pin
Çocuk Korumalı UPS Priz

502-01XX0Y-263



Ups Socket Outlet With Earth Pin
UPS Priz

502-01XX0Y-268



Double Pole Switch
İki Kutuplu Anahtar

502-01XX0Y-269



1 Gang 2Way Switch + Control Switch Light
Veavien + Light Anahtarı

502-01XX0Y-281



Child Protection Socket Outlet Without Earthed
Çocuk Korumalı Priz

502-01XX0Y-286



Dimmer 1000W
Dimmer 1000W

502-00XX0Y-112



Dimmer 500W CE
Dimmer 500W CE

502-00XX0Y-144



SAT Socket Outlet
(RG6 F KONNEKTÖR)
Uydu Priz - (RG6 F KONNEKTÖR)

502-00XX0Y-180



Dimmer 300W CE
Dimmer 300W CE

502-00XX0Y-212



TV + Radio Socket Outlet Through Line
TV + Rad - Geçişli

502-00XX0Y-220



Numeris Telephone Socket Outlet
Nümeris Priz

502-00XX0Y-221



Double Numeris Telephone Socket Outlet
İkili Nümeris Priz

502-00XX0Y-222



Tv Socket Outlet Through Line
TV Priz - Geçişli

502-00XX0Y-224



TV + Radio Socket Outlet End Of Line
TV + Rad - Sonlu

502-00XX0Y-225



Tv Socket Outlet Without Resistance
Tv Priz-Dirençsiz

502-00XX0Y-232



Tv + Rad + SAT Socket Outlet Through Line
TV + Rad + SAT Priz-Geçişli

502-00XX0Y-233



Tv + Rad + SAT Socket Outlet End Of Line
TV + Rad + SAT - Sonlu

502-00XX0Y-234



Music Hi Fi Socket Outlet 1Gang
Müzik Yayın Prizi

502-00XX0Y-235



Music Hi Fi Socket Outlet 2Gang
2'li Müzik Yayın Prizi

502-00XX0Y-241



220V Ventilator Control Switch 200W
Üçlü Klima Anahtarı

502-00XX0Y-279

* To select color of product please replace the Y with the code: Without Cordon 0, Fixline 1, White Cordon 2, Cream Cordon 3.

* To select color of product please replace the XX with the color code: White 02, Cream 03, Grey 15, Matt Gold 13, Fume 11.

*Ürün renklerini belirtmek için ürün kodundaki Y yerine; 0 Kordonsuz, 1 Fixline, 2 Beyaz Kordonlu, 3 Krem Kordonlu.

*Ürün renklerini belirtmek için ürün kodundaki XX yerine; 02 Beyaz, 03 Krem, 15 Gri, 13 Mat Altın, 11 Füme gelecek şekilde sipariş verilmelidir.

Functions / Fonksiyonlar



**Tv Socket Outlet
End Of Line**
TV Priz - Sonlu

502-00XX0Y-246



Data Socket Outlet (CAT6)
Data Priz (CAT6)

502-00XX0Y-247



**Double Data
Socket Outlet (CAT6)**
2'li Data Prizi (CAT6)

502-00XX0Y-248



**Data + Numeris Telephone
Socket Outlet (CAT6)**
Data + Nümeris Telefon Prizi

502-00XX0Y-249



**Data + Numeris Telephone
Socket Outlet Without Jack**
Data + Nümeris Telefon Prizi Jaksız

502-00XX0Y-260



**Shielded Tv Socket Outlet
End Of Line**
TV Priz Ekranlı - Sonlu

502-00XX0Y-273



**Shielded Tv Socket Outlet
Without Resistance**
TV Priz Ekranlı - Dirençsiz

502-00XX0Y-274



**Shielded Tv Socket Outlet
Through Line**
TV Priz Ekranlı - Geçişli

502-00XX0Y-272



**TV + SAT Socket Outlet
Through Line**
TV + SAT - Geçişli

502-00XX0Y-289



**TV + SAT
Socket Outlet End Of Line**
TV + SAT - Sonlu

502-00XX0Y-290



SAT Socket Outlet F Type
Uydu Priz - F Dişi Tipi

502-00XX0Y-280



**SAT Socket Outlet F Type
Through Line**
Uydu Priz - F Dişi Tipi
Geçişli

502-01XX0Y-287



**SAT Socket Outlet F Type
End Of Line**
Uydu Priz - F Dişi Tipi Sonlu

502-01XX0Y-288



Cable Outlet Cover
Kablo Çıkış Kapağı

502-00XX0Y-298



**Child Protection Socket
Outlet With Hinged Lid**
Çocuk Korumalı
Kapaklı Topraklı Priz

502-01XX0Y-219

* To select color of product please replace the Y with the code: Without Cordon 0, Fixline 1, White Cordon 2, Cream Cordon 3.

* To select color of product please replace the XX with the color code: White 02, Cream 03, Grey 15, Matt Gold 13, Fume 11.

*Ürün renklerini belirtmek için ürün kodundaki Y yerine; 0 Kordonsuz, 1 Fixline, 2 Beyaz Kordonlu, 3 Krem Kordonlu.

*Ürün renklerini belirtmek için ürün kodundaki XX yerine; 02 Beyaz, 03 Krem, 15 Gri, 13 Mat Altın, 11 Füme gelecek şekilde sipariş verilmelidir.

Functions / Fonksiyonlar



Energy Saver Delayed
Optik Algılamalı Enerji
Saver Gecikmeli

502-00XX0Y-258



**Energy Saver Delayed Without
Relay / Enerji Saver Özel
Logolu Gecikmeli**

502-00XX0Y-259



Energy Saver + Keyholder
Enerji saver + Anahtarlık

502-00XX0Y-267



**220V Ventilator
Control Switch 200W**
220V - 200W Fan Dimmer

502-00XX0Y-278



**Dimmer 500W CE With
Filter**
Dimmer 500W CE Filtreli

502-00XX0Y-244



**Music Volume
Control Switch**
Müzik Yayın Anahtarı

502-00XX0Y-261



**Air Conditioner
Switch 25A**
25A Klima Anahtarı

502-00XX0Y-275



Heater Switch 20 A
20 A Isıtıcı Anahtar

502-00XX0Y-276



Double Socket Outlet Earthed
2'li Sıva Altı Topraklı Priz

502-01XX0Y-907



**Double Socket Outlet Without
Earthed / 2'li Sıva Altı Priz**

502-01XX0Y-908

* To select color of product please replace the Y with the code: Without Cordon 0, Fixline 1, White Cordon 2, Cream Cordon 3.

* To select color of product please replace the XX with the color code: White 02, Cream 03, Grey 15, Matt Gold 13, Fume 11.

*Ürün renklerini belirtmek için ürün kodundaki Y yerine; 0 Kordonsuz, 1 Fixline, 2 Beyaz Kordonlu, 3 Krem Kordonlu.

*Ürün renklerini belirtmek için ürün kodundaki XX yerine; 02 Beyaz, 03 Krem, 15 Gri, 13 Mat Altın, 11 Füme gelecek şekilde sipariş verilmelidir.

turn on the life

eva

Eva (IP54)

Practical solution against moisture and dust...

Suitable for humid and dusty environments without cable lines with IP54 feature.

Nemlenmeye veya tozlanmaya müsait yerler için pratik çözüm...

IP54 özelliğiyle, kablo hattı olmayan nemli veya tozlu yerlerin vazgeçilmezi.



ELBI
ELECTRIC

Functions / Fonksiyonlar



1Gang 1Way Switch
Anahtar

554-01XX00-200



1 Way Switch - Illuminated
Işıklı Anahtar

554-01XX00-201



2Gang 1Way Switch
Komütatör

554-01XX00-202



**Double One Way Switch
Illuminated**
Işıklı Komütatör

554-01XX00-203



Control Switch Door
Kapi Otomatigi Anahtar

554-01XX00-204



Control Switch Light
Light

554-01XX00-205



Control Switch Bell
Zil

554-01XX00-207



1Gang 2Way Switch
Vavien

554-01XX00-209



Two Way Switch-Illuminated
Işıklı Vavien

554-01XX00-210



Double Two Way Switch
Komütatör Vavien

554-01XX00-211



Two Way Switch-Intermediate
Ara Vavien

554-01XX00-214



**IP54 Socket Outlet Earthed
With Hinged Lid**
IP54 Kapaklı Topraklı Priz

554-01XX00-218



**IP54 Child Protection UPS Socket
Outlet / IP54 Çocuk Korumalı
Kapaklı UPS Priz**

554-01XX00-163



**Socket Outlet Earthed &
Socket Outlet Earthed**
Topraklı Priz - Topraklı Priz Kombine

554-01XX00-938

* To select color of product please replace the XX with the color code: White 02, Gray 15.

* Ürün renklerini belirtmek için ürün kodundaki XX yerine; 02 Beyaz, 15 Gri gelecek şekilde sipariş verilmelidir.

Functions / Fonksiyonlar



IP54 Child Protection Earth Socket & UPS Socket With Cover
IP54 Çocuk Korumalı Kapaklı UPS Priz Kombine

554-01XX00-933



1Gang 1Way Switch & Socket Outlet Earthed
Anahtar-Topraklı Priz Kombine

554-01XX00-920



Illuminated 1Gang 1Way Switch&Socket Outlet Earthed
Işıklı Anahtar - Topraklı Priz Kombine

554-01XX00-921



2Gang 1Way Switch & Socket Outlet Earthed
Komütatör - Topraklı Priz Kombine

554-01XX00-922



Illuminated 2Gang 1Way Switch&Socket Outlet Earthed
Işıklı Komütatör -Topraklı Priz Kombine

554-01XX00-923



Control Switch Light&Socket Outlet Earthed
Light Anahtarı - Topraklı Priz Kombine

554-01XX00-925



1Gang 2Way Switch &Socket Outlet Earthed
Veavien - Topraklı Priz Kombine

554-01XX00-929



1Gang 2Way Switch Illuminated & Socket Outlet Earthed
Işık Veavien -Topraklı Priz Kombine

554-01XX00-930



2Gang 2Way Switch & Socket Outlet Earthed
Komütatör Veavien -Topraklı Priz Kombine

554-01XX00-931

* To select color of product please replace the XX with the color code: White 02, Gray 15.

* Ürün renklerini belirtmek için ürün kodundaki XX yerine; 02 Beyaz, 15 Gri gelecek şekilde sipariş verilmelidir.

1.number: protection against solid objects		2.number:Degree of protection against water								
		0	1	2	3	4	5	6	7	8
		no protected	protected against dripping water	15 degree tilt protected against dripping water	60 degree tilt protected against dripping water	protected against splashing water	protected against spraying water	protected against strong sea wave	protected against impact of dip in water	protected against keeping of underwater
no protected	0	IP 00	IP 01	IP 02	-	-	-	-	-	-
protected against bigger than 50mm of solid objects	1	IP 10	IP 11	IP 12	IP 13	-	-	-	-	-
protected against bigger than 50mm of solid objects	2	IP 20 ALSU	IP 21	IP 22	IP 23	-	-	-	-	-
protected against bigger than 2,5mm of solid objects	3	IP 30	IP 31	IP 32	IP 33	IP34	-	-	-	-
protected against bigger than 1mm of solid objects	4	IP 40	IP 41	IP 42	IP 43	IP 44	IP 45	IP 46	-	-
protected against dust	5	-	-	-	-	IP 54 EVA	IP 55	IP 56	-	-

1. rakam: Katı cisimlere karşı koruma derecesi		2. rakam: Suya karşı koruma derecesi								
		0	1	2	3	4	5	6	7	8
		Korumasız	Damlayan suya karşı korumalı	15°C'ye kadar damlayan suya karşı korumalı	60°C'ye kadar damlayan suya karşı korumalı	Sıçrayan suya karşı korumalı	Su püskürtmesine karşı korumalı	Şiddetli deniz dalgalarına karşı korumalı	Suya daldırmanın etkilerine karşı korumalı	Su altında bırakılmaya karşı korumalı
Korumasız	0	IP 00	IP 01	IP 02	-	-	-	-	-	-
50 mm.'den büyük katı cisimlere karşı korumalı	1	IP 10	IP 11	IP 12	IP 13	-	-	-	-	-
50 mm.'den büyük katı cisimlere karşı korumalı	2	IP 20 ALSU	IP 21	IP 22	IP 23	-	-	-	-	-
2,5 mm.'den büyük katı cisimlere karşı korumalı	3	IP 30	IP 31	IP 32	IP 33	IP 34	-	-	-	-
1 mm.'den büyük katı cisimlere karşı korumalı	4	IP 40	IP 41	IP 42	IP 43	IP 44	IP 45	IP 46	-	-
Toza karşı korumalı	5	-	-	-	-	IP 54 EVA	IP 55	IP 56	-	-

turn on the life

alsu *Alsu (IP20)*

Practical solution for surface mounted areas!

IP20 is ideal for places without cable lines.

Sivaüstü yerler için pratik çözüm!

*IP20 kablo hattı olmayan yerlerde
kullanmanız için idealdir.*



ELBI
ELECTRIC



**Als White 1 Gang 1Way
Switch**

ALSU Beyaz Anahtar

504-010200-200



**Als Cream 1 Gang 1Way
Switch**

ALSU Krem Anahtar

504-010300-200



**Als Beech 1 Gang 1Way
Switch**

ALSU Kayın Anahtar

504-010700-200



**Als Cherry 1 Gang 1Way
Switch**

ALSU Kiraz Anahtar

504-010600-200



**Als Vantablack 1 Gang
1Way Switch**

ALSU Vantablack Anahtar

504-014800-200

Functions / Fonksiyonlar



1Gang 1Way Switch
Anahtar

504-01XX00-200



One Way Switch - Illuminated
Işıklı Anahtar

504-01XX00-201



2 Gang 1Way Switch
Komütatör

504-01XX00-202



Double One Way Switch Illuminated
Işıklı Komütatör

504-01XX00-203



Control Switch Door
Kapı Otomatığı

504-01XX00-204



Control Switch Light
Light

504-01XX00-205



Control Switch Bell
Zil

504-01XX00-207



1Gang 2Way Switch
Vavien

504-01XX00-209



Two Way Switch - Illuminated
Işıklı Vavien

504-01XX00-210



Double Two Way Switch
Komütatör Vavien

504-01XX00-211



1Gang 2Way Switch Intermediate
Ara Vavien

504-01XX00-214

* To select color of product please replace the XX with the color code: White 02, Cream 03, Beech 07, Cheery 06, Vantablack 48.

* Ürün renklerini belirtmek için ürün kodundaki XX yerine; 02 Beyaz, 03 Krem, 07 Kayın, 06 Kiraz, 48 Vantablack gelecek şekilde sipariş verilmelidir.

Functions / Fonksiyonlar



Socket Outlet Without Earthed
Priz

504-01XX00-215



Socket Outlet Without Earthed
(Porcelain)
Priz (Porselen)

504-00XX00-215



Socket Outlet Earthed
Topraklı Priz

504-01XX00-217



Socket Outlet Earthed
(Porcelain)
Topraklı Priz (Porselen)

504-00XX00-217



Socket Outlet With Hinge Lid
(IP54)
Şeffaf Kapaklı Topraklı Priz

504-01XX15-218



Child Protection UPS Socket
Outlet With Hinge Lid (IP54)
Çocuk Korumalı Şeffaf Kapaklı UPS Priz

504-01XX00-163



Tv Socket Outlet - Through Line
TV Priz - Geçişli

504-00XX00-224



Tv Socket Outlet Without
Resistance
TV Priz - Dirençsiz

504-00XX00-232



Tv - Socket Outlet - End Of Line
TV Priz - Sonlu

504-00XX00-246



Data Socket Outlet (CAT6)
Data Priz (CAT6)

504-00XX00-247



Numeris Telephone Socket Outlet
Nümeris Priz

504-00XX00-221



Double Socket Outlet Earthed
Sıva Üstü İkili Topraklı Priz

504-01XX00-907



Double Socket Outlet Without Earthed
Sıva Üstü İkili Priz

504-01XX00-908

* To select color of product please replace the XX with the color code: White 02, Cream 03, Beech 07, Cheery 06, Vantablack 48.

* Ürün renklerini belirtmek için ürün kodundaki XX yerine; 02 Beyaz, 03 Krem, 07 Kayın, 06 Kiraz, 48 Vantablack gelecek şekilde sipariş verilmelidir.

turn on the life

myra

Our Myra series group sockets allow charging of multiple technological devices at the same time. Whether at home or in the office, everything stays connected to electricity thanks to these sockets designed to suit your needs. It allows you to charge your devices faster and more efficiently with USB charging ports. Instead of dealing with cable clutter, everything is gathered in one place.

Myra serisi grup prizlerimiz, aynı anda birden fazla teknolojik cihazın şarj edilmesine olanak tanır. İster evde, ister ofiste, ihtiyacınıza göre tasarlanmış bu prizler sayesinde her şey elektriğe bağlı kalır. USB şarj portları ile cihazlarınızı daha hızlı ve daha verimli bir şekilde şarj etmenizi sağlar. Kablo karmaşasıyla uğraşmak yerine, her şey tek bir yerde toplanır.



ELBI
ELECTRIC

2Gang Child Protected Without Earthed - GP 2'li Çocuk Korumalı Grup Priz - GP (Topraksız)

	Product Code Ürün Kodu	Product Name Ürün Adı	Length Uzunluk	Units Per Box Kutudaki Adet	Units Per Package Koliadaki Adet
2X1	527-010200-200	2Gang Child Protected Without Earthed Gp Cordless / 2'li Çocuk Korumalı Gp Klemensli	-	-	50
	527-010201-230	2Gang Child Protected Without Earthed Gp Cord (2x1) / 2'li Çocuk Korumalı Gp (2x1)	1mt	-	12
	527-010215-230	2Gang Child Protected Without Earthed Gp Cord (2x1) / 2'li Çocuk Korumalı Gp (2x1)	1,5mt	-	12
	527-010202-230	2Gang Child Protected Without Earthed Gp Cord (2x1) / 2'li Çocuk Korumalı Gp (2x1)	2mt	-	12
	527-010203-230	2Gang Child Protected Without Earthed Gp Cord (2x1) / 2'li Çocuk Korumalı Gp (2x1)	3mt	-	12
	527-010205-230	2Gang Child Protected Without Earthed Gp Cord (2x1) / 2'li Çocuk Korumalı Gp (2x1)	5mt	-	12
2X0,75	527-010201-250	2Gang Child Protected Without Earthed Gp Cord (2x0,75) / 2'li Çocuk Korumalı Gp (2x0,75)	1mt	-	12
	527-010215-250	2Gang Child Protected Without Earthed Gp Cord (2x0,75) / 2'li Çocuk Korumalı Gp (2x0,75)	1,5mt	-	12
	527-010202-250	2Gang Child Protected Without Earthed Gp Cord (2x0,75) / 2'li Çocuk Korumalı Gp (2x0,75)	2mt	-	12
	527-010203-250	2Gang Child Protected Without Earthed Gp Cord (2x0,75) / 2'li Çocuk Korumalı Gp (2x0,75)	3mt	-	12
	527-010205-250	2Gang Child Protected Without Earthed Gp Cord (2x0,75) / 2'li Çocuk Korumalı Gp (2x0,75)	5mt	-	12



3Gang Child Protected Without Earthed - GP 3'lü Çocuk Korumalı Grup Priz - GP (Topraksız)

	Product Code Ürün Kodu	Product Name Ürün Adı	Length Uzunluk	Units Per Box Kutudaki Adet	Units Per Package Koliadaki Adet
2X1	527-010200-300	3Gang Child Protected Without Earthed Gp Cordless / 3'lü Çocuk Korumalı Gp Klemensli	-	-	45
	527-010201-330	3Gang Child Protected Without Earthed Gp Cord (2x1) / 3'lü Çocuk Korumalı Gp (2x1)	1mt	-	12
	527-010215-330	3Gang Child Protected Without Earthed Gp Cord (2x1) / 3'lü Çocuk Korumalı Gp (2x1)	1,5mt	-	12
	527-010202-330	3Gang Child Protected Without Earthed Gp Cord (2x1) / 3'lü Çocuk Korumalı Gp (2x1)	2mt	-	12
	527-010203-330	3Gang Child Protected Without Earthed Gp Cord (2x1) / 3'lü Çocuk Korumalı Gp (2x1)	3mt	-	12
	527-010205-330	3Gang Child Protected Without Earthed Gp Cord (2x1) / 3'lü Çocuk Korumalı Gp (2x1)	5mt	-	12
2X0,75	527-010201-350	3Gang Child Protected Without Earthed Gp Cord / 3'lü Çocuk Korumalı Gp (2x0,75)	1mt	-	12
	527-010215-350	3Gang Child Protected Without Earthed Gp Cord (2x0,75) / 3'lü Çocuk Korumalı Gp (2x0,75)	1,5mt	-	12
	527-010202-350	3Gang Child Protected Without Earthed Gp Cord (2x0,75) / 3'lü Çocuk Korumalı Gp (2x0,75)	2mt	-	12
	527-010203-350	3Gang Child Protected Without Earthed Gp Cord (2x0,75) / 3'lü Çocuk Korumalı Gp (2x0,75)	3mt	-	12
	527-010205-350	3Gang Child Protected Without Earthed Gp Cord (2x0,75) / 3'lü Çocuk Korumalı Gp (2x0,75)	5mt	-	12



3Gang Child Protected Without Earthed UPS - GP 3'lü Çocuk Korumalı UPS - GP (Topraksız)

	Product Code Ürün Kodu	Product Name Ürün Adı	Length Uzunluk	Units Per Box Kutudaki Adet	Units Per Package Koliadaki Adet
3X1	527-010200-304	3Gang Child Protected Without Earthed Cordless / 3'lü Çocuk Korumalı UPS Gp Klemensli	-	-	45
	527-010201-314	3Gang Child Protected UPS Without Earthed Cord (3x1) / 3'lü Çocuk Korumalı UPS Gp (3x1)	1mt	-	12
	527-010215-314	3Gang Child Protected UPS Without Earthed Cord (3x1) / 3'lü Çocuk Korumalı UPS Gp (3x1)	1,5mt	-	12
	527-010202-314	3Gang Child Protected UPS Without Earthed Cord (3x1) / 3'lü Çocuk Korumalı UPS Gp (3x1)	2mt	-	12
	527-010203-314	3Gang Child Protected UPS Without Earthed Cord (3x1) / 3'lü Çocuk Korumalı UPS Gp (3x1)	3mt	-	12
	527-010205-314	3Gang Child Protected UPS Without Earthed Cord (3x1) / 3'lü Çocuk Korumalı UPS Gp (3x1)	5mt	-	12
3X1,5	527-010201-324	3Gang Child Protected UPS Without Earthed Cord (3x1,5) / 3'lü Çocuk Korumalı UPS Gp (3x1,5)	1mt	-	12
	527-010215-324	3Gang Child Protected UPS Without Earthed Cord (3x1,5) / 3'lü Çocuk Korumalı UPS Gp (3x1,5)	1,5mt	-	12
	527-010202-324	3Gang Child Protected UPS Without Earthed Cord (3x1,5) / 3'lü Çocuk Korumalı UPS Gp (3x1,5)	2mt	-	12
	527-010203-324	3Gang Child Protected UPS Without Earthed Cord (3x1,5) / 3'lü Çocuk Korumalı UPS Gp (3x1,5)	3mt	-	12
	527-010205-324	3Gang Child Protected UPS Without Earthed Cord (3x1,5) / 3'lü Çocuk Korumalı UPS Gp (3x1,5)	5mt	-	12



3Gang Child Protected With Rocker Switch UPS - GP 3'lü Çocuk Korumalı Anahtarlı UPS - GP (Topraksız)

	Product Code Ürün Kodu	Product Name Ürün Adı	Length Uzunluk	Units Per Box Kutudaki Adet	Units Per Package Koliadaki Adet
3X1	527-010200-305	3Gang Child Protected With Rocker Switch UPS Cordless / 3'lü Çocuk Korumalı Anahtarlı UPS Gp Klemensli	-	-	25
	527-010201-315	3Gang Child Protected With Rocker Switch UPS Cord (3x1) / 3'lü Çocuk Korumalı Anahtarlı UPS Gp (3x1)	1mt	-	12
	527-010215-315	3Gang Child Protected With Rocker Switch UPS Cord (3x1) / 3'lü Çocuk Korumalı Anahtarlı UPS Gp (3x1)	1,5mt	-	12
	527-010202-315	3Gang Child Protected With Rocker Switch UPS Cord (3x1) / 3'lü Çocuk Korumalı Anahtarlı UPS Gp (3x1)	2mt	-	12
	527-010203-315	3Gang Child Protected With Rocker Switch UPS Cord (3x1) / 3'lü Çocuk Korumalı Anahtarlı UPS Gp (3x1)	3mt	-	12
	527-010205-315	3Gang Child Protected With Rocker Switch UPS Cord (3x1) / 3'lü Çocuk Korumalı Anahtarlı UPS Gp (3x1)	5mt	-	12
3X1,5	527-010201-325	3Gang Child Protected With Rocker Switch UPS Cord (3x1,5) / 3'lü Çocuk Korumalı Anahtarlı UPS Gp (3x1,5)	1mt	-	12
	527-010215-325	3Gang Child Protected With Rocker Switch UPS Cord (3x1,5) / 3'lü Çocuk Korumalı Anahtarlı UPS Gp (3x1,5)	1,5mt	-	12
	527-010202-325	3Gang Child Protected With Rocker Switch UPS Cord (3x1,5) / 3'lü Çocuk Korumalı Anahtarlı UPS Gp (3x1,5)	2mt	-	12
	527-010203-325	3Gang Child Protected With Rocker Switch UPS Cord (3x1,5) / 3'lü Çocuk Korumalı Anahtarlı UPS Gp (3x1,5)	3mt	-	12
	527-010205-325	3Gang Child Protected With Rocker Switch UPS Cord (3x1,5) / 3'lü Çocuk Korumalı Anahtarlı UPS Gp (3x1,5)	5mt	-	12



3Gang Child Protected Without Earthed UPS With USB - GP 3'lü Çocuk Korumalı USB'li UPS - GP

	Product Code Ürün Kodu	Product Name Ürün Adı	Length Uzunluk	Units Per Box Kutudaki Adet	Units Per Package Koliadaki Adet
3X1	527-010201-316	3Gang Child Protected Without Earthed UPS With USB Cord (3x1) / 3'lü Çocuk Korumalı USB'li UPS Gp (3x1)	1mt	-	12
	527-010215-316	3Gang Child Protected Without Earthed UPS With USB Cord (3x1) / 3'lü Çocuk Korumalı USB'li UPS Gp (3x1)	1,5mt	-	12
	527-010202-316	3Gang Child Protected Without Earthed UPS With USB Cord (3x1) / 3'lü Çocuk Korumalı USB'li UPS Gp (3x1)	2mt	-	12
	527-010203-316	3Gang Child Protected Without Earthed UPS With USB Cord (3x1) / 3'lü Çocuk Korumalı USB'li UPS Gp (3x1)	3mt	-	12
	527-010205-316	3Gang Child Protected Without Earthed UPS With USB Cord (3x1) / 3'lü Çocuk Korumalı USB'li UPS Gp (3x1)	5mt	-	12
3X1,5	527-010201-326	3Gang Child Protected Without Earthed UPS With USB Cord (3x1,5) / 3'lü Çocuk Korumalı USB'li UPS Gp (3x1,5)	1mt	-	12
	527-010215-326	3Gang Child Protected Without Earthed UPS With USB Cord (3x1,5) / 3'lü Çocuk Korumalı USB'li UPS Gp (3x1,5)	1,5mt	-	12
	527-010202-326	3Gang Child Protected Without Earthed UPS With USB Cord (3x1,5) / 3'lü Çocuk Korumalı USB'li UPS Gp (3x1,5)	2mt	-	12
	527-010203-326	3Gang Child Protected Without Earthed UPS With USB Cord (3x1,5) / 3'lü Çocuk Korumalı USB'li UPS Gp (3x1,5)	3mt	-	12
	527-010205-326	3Gang Child Protected Without Earthed UPS With USB Cord (3x1,5) / 3'lü Çocuk Korumalı USB'li UPS Gp (3x1,5)	5mt	-	12

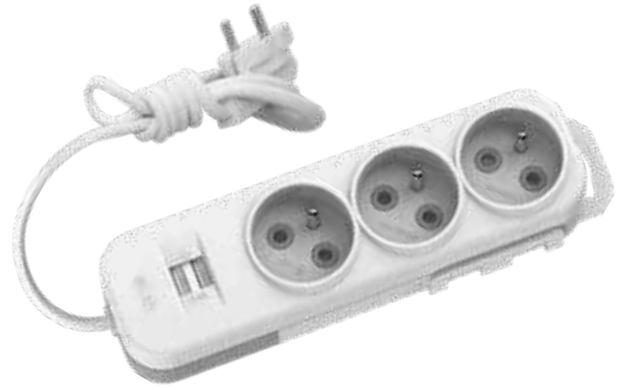

4Gang Child Protected Without Earthed - GP 4'lü Çocuk Korumalı Grup Priz - GP (Topraksız)

	Product Code Ürün Kodu	Product Name Ürün Adı	Length Uzunluk	Units Per Box Kutudaki Adet	Units Per Package Koliadaki Adet
2X1	527-010200-400	4Gang Child Protected Without Earthed Cordless / 4'lü Çocuk Korumalı Gp Klemensli	-	-	45
	527-010201-430	4Gang Child Protected Without Earthed Cord (2x1) / 4'lü Çocuk Korumalı Gp (2x1)	1mt	-	12
	527-010215-430	4Gang Child Protected Without Earthed Cord (2x1) / 4'lü Çocuk Korumalı Gp (2x1)	1,5mt	-	12
	527-010202-430	4Gang Child Protected Without Earthed Cord (2x1) / 4'lü Çocuk Korumalı Gp (2x1)	2mt	-	12
	527-010203-430	4Gang Child Protected Without Earthed Cord (2x1) / 4'lü Çocuk Korumalı Gp (2x1)	3mt	-	12
	527-010205-430	4Gang Child Protected Without Earthed Cord (2x1) / 4'lü Çocuk Korumalı Gp (2x1)	5mt	-	12
2X0,75	527-010201-450	4Gang Child Protected Without Earthed Cord (2x0,75) / 4'lü Çocuk Korumalı Gp (2x0,75)	1mt	-	12
	527-010215-450	4Gang Child Protected Without Earthed Cord (2x0,75) / 4'lü Çocuk Korumalı Gp (2x0,75)	1,5mt	-	12
	527-010202-450	4Gang Child Protected Without Earthed Cord (2x0,75) / 4'lü Çocuk Korumalı Gp (2x0,75)	2mt	-	12
	527-010203-450	4Gang Child Protected Without Earthed Cord (2x0,75) / 4'lü Çocuk Korumalı Gp (2x0,75)	3mt	-	12
	527-010205-450	4Gang Child Protected Without Earthed Cord (2x0,75) / 4'lü Çocuk Korumalı Gp (2x0,75)	5mt	-	12



2Gang Child Protected Earthed Cordless 2'li Çocuk Korumalı Grup Priz Topraklı (TGP)

	Product Code Ürün Kodu	Product Name Ürün Adı	Length Uzunluk	Units Per Box Kutudaki Adet	Units Per Package Koliadaki Adet
3X1	527-010200-201	2Gang Child Protected Earthed Cordless / 2'li Çocuk Korumalı Tgp Klemensli	-	-	30
	527-010201-211	2Gang Child Protected Earthed Cord (3x1) / 2'li Çocuk Korumalı Tgp (3x1)	1mt	-	12
	527-010215-211	2Gang Child Protected Earthed Cord (3x1) / 2'li Çocuk Korumalı Tgp (3x1)	1,5mt	-	12
	527-010202-211	2Gang Child Protected Earthed Cord (3x1) / 2'li Çocuk Korumalı Tgp (3x1)	2mt	-	12
	527-010203-211	2Gang Child Protected Earthed Cord (3x1) / 2'li Çocuk Korumalı Tgp (3x1)	3mt	-	12
	527-010205-211	2Gang Child Protected Earthed Cord (3x1) / 2'li Çocuk Korumalı Tgp (3x1)	5mt	-	12
3X1,5	527-010201-221	2Gang Child Protected Earthed Cord (3x1,5) / 2'li Çocuk Korumalı Tgp (3x1,5)	1mt	-	12
	527-010215-221	2Gang Child Protected Earthed Cord (3x1,5) / 2'li Çocuk Korumalı Tgp (3x1,5)	1,5mt	-	12
	527-010202-221	2Gang Child Protected Earthed Cord (3x1,5) / 2'li Çocuk Korumalı Tgp (3x1,5)	2mt	-	12
	527-010203-221	2Gang Child Protected Earthed Cord (3x1,5) / 2'li Çocuk Korumalı Tgp (3x1,5)	3mt	-	12
	527-010205-221	2Gang Child Protected Earthed Cord (3x1,5) / 2'li Çocuk Korumalı Tgp (3x1,5)	5mt	-	12



3Gang Child Protected Earthed Cordless 3'lü Çocuk Korumalı Grup Priz Topraklı (TGP)

	Product Code Ürün Kodu	Product Name Ürün Adı	Length Uzunluk	Units Per Box Kutudaki Adet	Units Per Package Koliadaki Adet
3X1	527-010200-301	3Gang Child Protected Earthed Cordless / 3'lü Çocuk Korumalı Tgp Klemensli	-	-	30
	527-010201-311	3Gang Child Protected Earthed Cord (3x1) / 3'lü Çocuk Korumalı Tgp (3x1)	1mt	-	12
	527-010215-311	3Gang Child Protected Earthed Cord (3x1) / 3'lü Çocuk Korumalı Tgp (3x1)	1,5mt	-	12
	527-010202-311	3Gang Child Protected Earthed Cord (3x1) / 3'lü Çocuk Korumalı Tgp (3x1)	2mt	-	12
	527-010203-311	3Gang Child Protected Earthed Cord (3x1) / 3'lü Çocuk Korumalı Tgp (3x1)	3mt	-	12
	527-010205-311	3Gang Child Protected Earthed Cord (3x1) / 3'lü Çocuk Korumalı Tgp (3x1)	5mt	-	12
3X1,5	527-010201-321	3Gang Child Protected Earthed Cord (3x1,5) / 3'lü Çocuk Korumalı Tgp (3x1,5)	1mt	-	12
	527-010215-321	3Gang Child Protected Earthed Cord (3x1,5) / 3'lü Çocuk Korumalı Tgp (3x1,5)	1,5mt	-	12
	527-010202-321	3Gang Child Protected Earthed Cord (3x1,5) / 3'lü Çocuk Korumalı Tgp (3x1,5)	2mt	-	12
	527-010203-321	3Gang Child Protected Earthed Cord (3x1,5) / 3'lü Çocuk Korumalı Tgp (3x1,5)	3mt	-	12
	527-010205-321	3Gang Child Protected Earthed Cord (3x1,5) / 3'lü Çocuk Korumalı Tgp (3x1,5)	5mt	-	12

3Gang Child Protected Earthed Cordless With Rocker Switch 3'lü Çocuk Korumalı Grup Priz Anahtarlı Topraklı (ATGP)

	Product Code Ürün Kodu	Product Name Ürün Adı	Length Uzunluk	Units Per Box Kutudaki Adet	Units Per Package Kolidaki Adet
3X1	527-010200-302	3Gang Child Protected Earthed Cordless With Rocker Switch / 3'lü Çocuk Korumalı Atgp Klemensli	-	-	25
	527-010201-312	3Gang Child Protected Earthed Cord With Rocker Switch (3x1) / 3'lü Çocuk Korumalı Atgp (3x1)	1mt	-	12
	527-010215-312	3Gang Child Protected Earthed Cord With Rocker Switch (3x1) / 3'lü Çocuk Korumalı Atgp (3x1)	1,5mt	-	12
	527-010202-312	3Gang Child Protected Earthed Cord With Rocker Switch (3x1) / 3'lü Çocuk Korumalı Atgp (3x1)	2mt	-	12
	527-010203-312	3Gang Child Protected Earthed Cord With Rocker Switch (3x1) / 3'lü Çocuk Korumalı Atgp (3x1)	3mt	-	12
	527-010205-312	3Gang Child Protected Earthed Cord With Rocker Switch (3x1) / 3'lü Çocuk Korumalı Atgp (3x1)	5mt	-	12
3X1,5	527-010201-322	3Gang Child Protected Earthed Cord With Rocker Switch (3x1,5) / 3'lü Çocuk Korumalı Atgp (3x1,5)	1mt	-	12
	527-010215-322	3Gang Child Protected Earthed Cord With Rocker Switch (3x1,5) / 3'lü Çocuk Korumalı Atgp (3x1,5)	1,5mt	-	12
	527-010202-322	3Gang Child Protected Earthed Cord With Rocker Switch (3x1,5) / 3'lü Çocuk Korumalı Atgp (3x1,5)	2mt	-	12
	527-010203-322	3Gang Child Protected Earthed Cord With Rocker Switch (3x1,5) / 3'lü Çocuk Korumalı Atgp (3x1,5)	3mt	-	12
	527-010205-322	3Gang Child Protected Earthed Cord With Rocker Switch (3x1,5) / 3'lü Çocuk Korumalı Atgp (3x1,5)	5mt	-	12



3Gang USB Child Protected Earthed With Cord 3'lü USB Çocuk Korumalı Topraklı Grup Priz

	Product Code Ürün Kodu	Product Name Ürün Adı	Length Uzunluk	Units Per Box Kutudaki Adet	Units Per Package Kolidaki Adet
3X1	527-040201-311	3Gang USB Child Protected Earthed Cord With 2Gang (3x1) / 3'lü USB'li Çocuk Korumalı TGP Kablolu (3x1)	1mt	-	12
	527-040215-311	3Gang USB Child Protected Earthed Cord With 2Gang (3x1) / 3'lü USB'li Çocuk Korumalı TGP Kablolu (3x1)	1,5mt	-	12
	527-040202-311	3Gang USB Child Protected Earthed Cord With 2Gang (3x1) / 3'lü USB'li Çocuk Korumalı TGP Kablolu (3x1)	2mt	-	12
	527-040203-311	3Gang USB Child Protected Earthed Cord With 2Gang (3x1) / 3'lü USB'li Çocuk Korumalı TGP Kablolu (3x1)	3mt	-	12
	527-040205-311	3Gang USB Child Protected Earthed Cord With 2Gang (3x1) / 3'lü USB'li Çocuk Korumalı TGP Kablolu (3x1)	5mt	-	12
3X1,5	527-040201-321	3Gang USB Child Protected Earthed Cord (3x1,5) / 3'lü USB'li Çocuk Korumalı TGP Kablolu (3x1,5)	1mt	-	12
	527-040215-321	3Gang USB Child Protected Earthed Cord (3x1,5) / 3'lü USB'li Çocuk Korumalı TGP Kablolu (3x1,5)	1,5mt	-	12
	527-040202-321	3Gang USB Child Protected Earthed Cord (3x1,5) / 3'lü USB'li Çocuk Korumalı TGP Kablolu (3x1,5)	2mt	-	12
	527-040203-321	3Gang USB Child Protected Earthed Cord (3x1,5) / 3'lü USB'li Çocuk Korumalı TGP Kablolu (3x1,5)	3mt	-	12
	527-040205-321	3Gang USB Child Protected Earthed Cord (3x1,5) / 3'lü USB'li Çocuk Korumalı TGP Kablolu (3x1,5)	5mt	-	12

4Gang Child Protected Earthed Cordless

4'lü Çocuk Korumalı Grup Priz Topraklı (TGP)

	Product Code Ürün Kodu	Product Name Ürün Adı	Length Uzunluk	Units Per Box Kutudaki Adet	Units Per Package Kolidaki Adet
3X1	527-010200-401	4Gang Child Protected Earthed Cordless / 4'lü Çocuk Korumalı Tgp Klemensli	-	-	25
	527-010201-411	4Gang Child Protected Earthed Cord (3x1) / 4'lü Çocuk Korumalı Tgp (3x1)	1mt	-	12
	527-010215-411	4Gang Child Protected Earthed Cord (3x1) / 4'lü Çocuk Korumalı Tgp (3x1)	1,5mt	-	12
	527-010202-411	4Gang Child Protected Earthed Cord (3x1) / 4'lü Çocuk Korumalı Tgp (3x1)	2mt	-	12
	527-010203-411	4Gang Child Protected Earthed Cord (3x1) / 4'lü Çocuk Korumalı Tgp (3x1)	3mt	-	12
	527-010205-411	4Gang Child Protected Earthed Cord (3x1) / 4'lü Çocuk Korumalı Tgp (3x1)	5mt	-	12
3X1,5	527-010201-421	4Gang Child Protected Earthed Cord (3x1,5) / 4'lü Çocuk Korumalı Tgp (3x1,5)	1mt	-	12
	527-010215-421	4Gang Child Protected Earthed Cord (3x1,5) / 4'lü Çocuk Korumalı Tgp (3x1,5)	1,5mt	-	12
	527-010202-421	4Gang Child Protected Earthed Cord (3x1,5) / 4'lü Çocuk Korumalı Tgp (3x1,5)	2mt	-	12
	527-010203-421	4Gang Child Protected Earthed Cord (3x1,5) / 4'lü Çocuk Korumalı Tgp (3x1,5)	3mt	-	12
	527-010205-421	4Gang Child Protected Earthed Cord (3x1,5) / 4'lü Çocuk Korumalı Tgp (3x1,5)	5mt	-	12



4Gang Child Protected Earthed Cordless With Rocker Switch

4'lü Grup Priz Anahtarlı Topraklı (ATGP)

	Product Code Ürün Kodu	Product Name Ürün Adı	Length Uzunluk	Units Per Box Kutudaki Adet	Units Per Package Kolidaki Adet
3X1	527-010200-402	4Gang Child Protected Earthed Cordless With Rocker Switch / 4'lü Çocuk Korumalı Atgp Klemensli	-	-	20
	527-010201-412	4Gang Child Protected Earthed Cord (3x1) / 4'lü Çocuk Korumalı Atgp (3x1)	1mt	-	12
	527-010215-412	4Gang Child Protected Earthed Cord (3x1) / 4'lü Çocuk Korumalı Atgp (3x1)	1,5mt	-	12
	527-010202-412	4Gang Child Protected Earthed Cord (3x1) / 4'lü Çocuk Korumalı Atgp (3x1)	2mt	-	12
	527-010203-412	4Gang Child Protected Earthed Cord (3x1) / 4'lü Çocuk Korumalı Atgp (3x1)	3mt	-	12
	527-010205-412	4Gang Child Protected Earthed Cord (3x1) / 4'lü Çocuk Korumalı Atgp (3x1)	5mt	-	12
3X1,5	527-010201-422	4Gang Child Protected Earthed Cord With Rocker Switch (3x1,5) / 4'lü Çocuk Korumalı Atgp (3x1,5)	1mt	-	12
	527-010215-422	4Gang Child Protected Earthed Cord With Rocker Switch (3x1,5) / 4'lü Çocuk Korumalı Atgp (3x1,5)	1,5mt	-	12
	527-010202-422	4Gang Child Protected Earthed Cord With Rocker Switch (3x1,5) / 4'lü Çocuk Korumalı Atgp (3x1,5)	2mt	-	12
	527-010203-422	4Gang Child Protected Earthed Cord With Rocker Switch (3x1,5) / 4'lü Çocuk Korumalı Atgp (3x1,5)	3mt	-	12
	527-010205-422	4Gang Child Protected Earthed Cord With Rocker Switch (3x1,5) / 4'lü Çocuk Korumalı Atgp (3x1,5)	5mt	-	12

4Gang USB Child Protected Earthed With Cord

4'lü USB'li Çocuk Korumalı Topraklı Grup Priz

	Product Code Ürün Kodu	Product Name Ürün Adı	Length Uzunluk	Units Per Box Kutudaki Adet	Units Per Package Kolidaki Adet
3X1	527-040201-411	4Gang Child Protected Earthed Cord With 2Gang USB (3x1) / 4'lü USB'li Çocuk Korumalı TGP Kablolu (3x1)	1mt	-	12
	527-040215-411	4Gang Child Protected Earthed Cord With 2Gang USB (3x1) / 4'lü USB'li Çocuk Korumalı TGP Kablolu (3x1)	1,5mt	-	12
	527-040202-411	4Gang Child Protected Earthed Cord With 2Gang USB (3x1) / 4'lü USB'li Çocuk Korumalı TGP Kablolu (3x1)	2mt	-	12
	527-040203-411	4Gang Child Protected Earthed Cord With 2Gang USB (3x1) / 4'lü USB'li Çocuk Korumalı TGP Kablolu (3x1)	3mt	-	12
	527-040205-411	4Gang Child Protected Earthed Cord With 2Gang USB (3x1) / 4'lü USB'li Çocuk Korumalı TGP Kablolu (3x1)	5mt	-	12
3X1,5	527-040201-421	4Gang USB Child Protected Earthed Cord (3x1,5) / 4'lü Usb'li Çocuk Korumalı TGP Kablolu (3x1,5)	1mt	-	12
	527-040215-421	4Gang USB Child Protected Earthed Cord (3x1,5) / 4'lü Usb'li Çocuk Korumalı TGP Kablolu (3x1,5)	1,5mt	-	12
	527-040202-421	4Gang USB Child Protected Earthed Cord (3x1,5) / 4'lü Usb'li Çocuk Korumalı TGP Kablolu (3x1,5)	2mt	-	12
	527-040203-421	4Gang USB Child Protected Earthed Cord (3x1,5) / 4'lü Usb'li Çocuk Korumalı TGP Kablolu (3x1,5)	3mt	-	12
	527-040205-421	4Gang USB Child Protected Earthed Cord (3x1,5) / 4'lü Usb'li Çocuk Korumalı TGP Kablolu (3x1,5)	5mt	-	12

6Gang Child Protected Earthed Cordless 6'lı Çocuk Korumalı Grup Priz Topraklı (TGP)

	Product Code Ürün Kodu	Product Name Ürün Adı	Length Uzunluk	Units Per Box Kutudaki Adet	Units Per Package Kolidaki Adet
3X1	527-010200-601	6Gang Child Protected Earthed Cordless / 6'lı Çocuk Korumalı Tgp Klemensli	-	-	20
	527-010201-611	6Gang Child Protected Earthed 1mt Cord (3X1) / 6'lı Çocuk Korumalı Tgp 1 mt (3X1)	1mt	-	12
	527-010215-611	6Gang Child Protected Earthed 2 mt Cord (3X1) / 6'lı Çocuk Korumalı Tgp 2 mt (3X1)	1,5mt	-	12
	527-010202-611	6Gang Child Protected Earthed 2 mt Cord (3X1) / 6'lı Çocuk Korumalı Tgp 2 mt (3X1)	2mt	-	12
	527-010203-611	6Gang Child Protected Earthed 3 mt Cord (3X1) / 6'lı Çocuk Korumalı Tgp 3 mt (3X1)	3mt	-	12
	527-010205-611	6Gang Child Protected Earthed 5 mt Cord (3X1) / 6'lı Çocuk Korumalı Tgp 5 mt (3X1)	5mt	-	12
3X1,5	527-010201-621	6Gang Child Protected Earthed 1mt Cord (3X1,5) / 6'lı Çocuk Korumalı Tgp 1mt (3X1,5)	1mt	-	12
	527-010215-621	6Gang Child Protected Earthed 2 mt Cord (3X1,5) / 6'lı Çocuk Korumalı Tgp 2mt (3X1,5)	1,5mt	-	12
	527-010202-621	6Gang Child Protected Earthed 2 mt Cord (3X1,5) / 6'lı Çocuk Korumalı Tgp 2mt (3X1,5)	2mt	-	12
	527-010203-621	6Gang Child Protected Earthed 3 mt Cord (3X1,5) / 6'lı Çocuk Korumalı Tgp 3mt (3X1,5)	3mt	-	12
	527-010205-621	6Gang Child Protected Earthed 5 mt Cord (3X1,5) / 6'lı Çocuk Korumalı Tgp 5mt (3X1,5)	5mt	-	12

6Gang Child Protected Earthed Cordless With Rocker Switch 6'lı Çocuk Korumalı Grup Priz Anahtarlı Topraklı (ATGP)

	Product Code Ürün Kodu	Product Name Ürün Adı	Length Uzunluk	Units Per Box Kutudaki Adet	Units Per Package Kolidaki Adet
3X1	527-010200-602	6Gang Child Protected Earthed Cordless With Rocker Switch / 6'lı Çocuk Korumalı Atgp Klemensli	-	-	40
	527-010201-612	6Gang Child Protected Earthed Cord With Rocker Switch (3x1) / 6'lı Çocuk Korumalı Atgp (3x1)	1mt	-	12
	527-010215-612	6Gang Child Protected Earthed Cord With Rocker Switch (3x1) / 6'lı Çocuk Korumalı Atgp (3x1)	1,5mt	-	12
	527-010202-612	6Gang Child Protected Earthed Cord With Rocker Switch (3x1) / 6'lı Çocuk Korumalı Atgp (3x1)	2mt	-	12
	527-010203-612	6Gang Child Protected Earthed Cord With Rocker Switch (3x1) / 6'lı Çocuk Korumalı Atgp (3x1)	3mt	-	12
	527-010205-612	6Gang Child Protected Earthed Cord With Rocker Switch (3x1) / 6'lı Çocuk Korumalı Atgp (3x1)	5mt	-	12
3X1,5	527-010201-622	6Gang Child Protected Earthed Cord With Rocker Switch (3x1,5) / 6'lı Çocuk Korumalı Atgp (3x1,5)	1mt	-	12
	527-010215-622	6Gang Child Protected Earthed Cord With Rocker Switch (3x1,5) / 6'lı Çocuk Korumalı Atgp (3x1,5)	1,5mt	-	12
	527-010202-622	6Gang Child Protected Earthed Cord With Rocker Switch (3x1,5) / 6'lı Çocuk Korumalı Atgp (3x1,5)	2mt	-	12
	527-010203-622	6Gang Child Protected Earthed Cord With Rocker Switch (3x1,5) / 6'lı Çocuk Korumalı Atgp (3x1,5)	3mt	-	12
	527-010205-622	6Gang Child Protected Earthed Cord With Rocker Switch (3x1,5) / 6'lı Çocuk Korumalı Atgp (3x1,5)	5mt	-	12

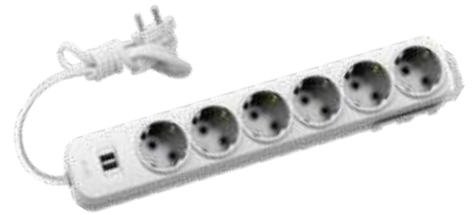
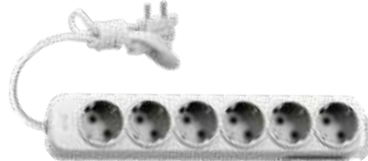
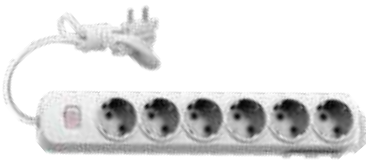

6Gang USB Child Protected Earthed With Cord 6'lı USB'li Çocuk Korumalı Topraklı Grup Priz

	Product Code Ürün Kodu	Product Name Ürün Adı	Length Uzunluk	Units Per Box Kutudaki Adet	Units Per Package Kolidaki Adet
3X1	527-040201-611	6Gang USB Child Protected Earthed Cord (3x1) / 6'lı USB'li Çocuk Korumalı TGP Kablolu (3x1)	1mt	-	12
	527-040215-611	6Gang USB Child Protected Earthed Cord (3x1) / 6'lı USB'li Çocuk Korumalı TGP Kablolu (3x1)	1,5mt	-	12
	527-040202-611	6Gang USB Child Protected Earthed Cord (3x1) / 6'lı USB'li Çocuk Korumalı TGP Kablolu (3x1)	2mt	-	12
	527-040203-611	6Gang USB Child Protected Earthed Cord (3x1) / 6'lı USB'li Çocuk Korumalı TGP Kablolu (3x1)	3mt	-	12
	527-040205-611	6Gang USB Child Protected Earthed Cord (3x1) / 6'lı USB'li Çocuk Korumalı TGP Kablolu (3x1)	5mt	-	12
3X1,5	527-040201-621	6Gang USB Child Protected Earthed Cord (3x1,5) / 6'lı Usb'li Çocuk Korumalı TGP Kablolu (3x1,5)	1mt	-	12
	527-040215-621	6Gang USB Child Protected Earthed Cord (3x1,5) / 6'lı Usb'li Çocuk Korumalı TGP Kablolu (3x1,5)	1,5mt	-	12
	527-040202-621	6Gang USB Child Protected Earthed Cord (3x1,5) / 6'lı Usb'li Çocuk Korumalı TGP Kablolu (3x1,5)	2mt	-	12
	527-040203-621	6Gang USB Child Protected Earthed Cord (3x1,5) / 6'lı Usb'li Çocuk Korumalı TGP Kablolu (3x1,5)	3mt	-	12
	527-040205-621	6Gang USB Child Protected Earthed Cord (3x1,5) / 6'lı Usb'li Çocuk Korumalı TGP Kablolu (3x1,5)	5mt	-	12

turn on the life

deniz

It's time to meet comfort!

Deniz Group Sockets are always with you whenever you want.

Rahatlıkla buluşmanın tam sırası!

Deniz Grup Prizler ihtiyaç duyduğunuz her an yanınızda.



ELBI
ELECTRIC

Group Sockets Series / Grup Priz Serisi



516-000200-203
2Gang Without
Earthed Cordless

2'Li GP KL

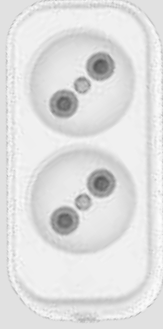

516-010200-203
Child Protected 2Gang
Without Earthed Cordless

2'Li Çocuk Korumalı GP KL



516-000200-201
2Gang Earthed
Cordless

2'Li TGP KL



516-010200-201
Child Protected 2Gang
Earthed Cordless

2'Li Çocuk Korumalı TGP KL



516-000200-202
2Gang Without Earthed
Cordless Switch

2'Li ATGP KL



516-010200-202
Child Protected 2Gang
Without Earthed
Cordless Switch

2'Li Çocuk Korumalı
ATGP KL



516-000200-303
3Gang Without
Earthed Cordless

3'Lü GP KL



516-010200-303
Child Protected 3Gang
Without Earthed Cordless

3'Lü Çocuk Korumalı GP KL



516-000200-301
3Gang Earthed
Cordless

3'Lü TGP KL



516-010200-301
Child Protected 3Gang
Earthed Cordless

3'Lü Çocuk Korumalı TGP KL



516-000200-302
3Gang Earthed
Cordless With
Rocker Switch

3'Lü ATGP KL

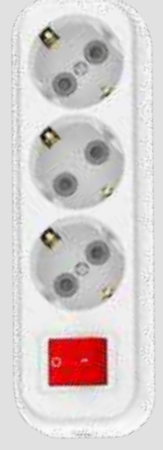

516-010200-302
Child Protected 3Gang
Earthed Cordless With
Rocker Switch

3'Lü Çocuk Korumalı
ATGP KL



Group Sockets Series / Grup Priz Serisi



516-000200-403
4Gang Without
Earthed Cordless
4'Lü GP KL



516-010200-403
Child Protected 4Gang
Without Earthed Cordless
4'Lü Çocuk Korumalı GP KL



516-000200-401
4Gang Earthed
Cordless
4'Lü TGP KL



516-010200-401
Child Protected 4Gang
Earthed Cordless
4'Lü Çocuk Korumalı TGP KL



516-000200-402
4Gang Earthed
Cordless With
Rocker Switch
4'Lü ATGP KL

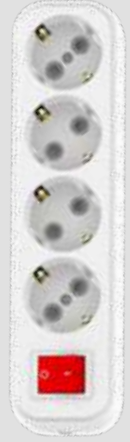

516-010200-402
Child Protected 4Gang
Earthed Cordless With
Rocker Switch
4'Lü Çocuk Korumalı
ATGP KL

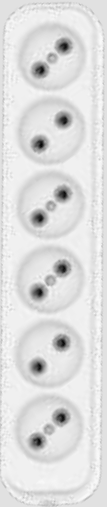

516-000200-603
6Gang Without
Earthed Cordless
6'Lü GP KL

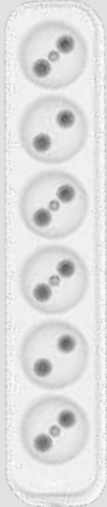

516-010200-603
Child Protected 6Gang
Without Earthed Cordless
6'Lü Çocuk Korumalı GP KL



516-000200-601
6Gang Earthed
Cordless
6'Lü TGP KL



516-010200-601
Child Protected 6Gang
Earthed Cordless
6'Lü Çocuk Korumalı TGP KL



516-000200-602
6Gang Earthed
Cordless With
Rocker Switch
6'Lü ATGP KL



516-010200-602
Child Protected 6Gang
Earthed Cordless With
Rocker Switch
6'Lü Çocuk Korumalı
ATGP KL

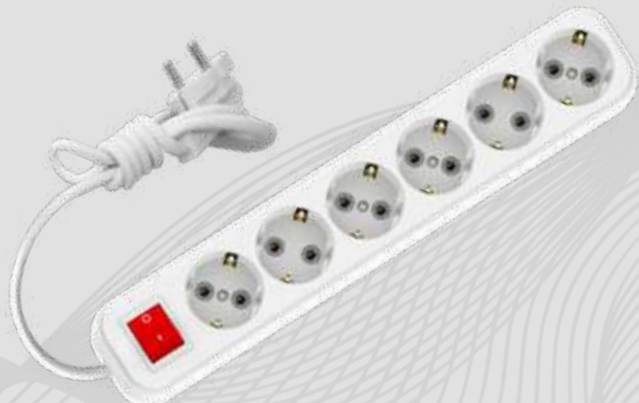

turn on the life

power control units

güç kontrol üniteleri



ELBI
ELECTRIC



RFID 3 x 16A Power Control Unit
RFID 3 X 16A Güç Kontrol Ünitesi

666-000316-127



RFID 2 x 16A Power Control Unit
RFID 2 X 16A Güç Kontrol Ünitesi

666-000216-127



Universal and Optic 2 x 16A Power Control Unit
Üniversal ve Optik 2 x 16A Güç Kontrol Ünitesi

666-000216-126



Universal and Optic 16A + 30 Power Control Unit
Üniversal ve Optik 16A + 30 Güç Kontrol Ünitesi

666-003016-126



Universal and Optic 16A Power Control Unit
Üniversal ve Optik 16A Güç Kontrol Ünitesi

666-000016-126



2x16A RF Power Control Unit
2X16A RF Güç Kontrol Ünitesi

666-000216-132

* Images on this page may be representative, please contact us for detailed information.

* Bu sayfadaki görsel öğeler temsili olabilir, detaylı bilgi için lütfen iletişime geçiniz.

turn on the life

accessories

aksesuarlar

Small details, excellent solutions...

ELBI offers qualified solutions for minor requirements with accessory options and befit your living sapce with different color alternatives..

Küçük detaylar, mükemmel sonuçlar...

EL-Bİ aksesuar seçenekleriyle hayatınızdaki küçük ihtiyaçlara kaliteli çözümler sunarken ; farklı renk alternatifleri ile mekânınıza rahatlıkla uyar.



ELBI
ELEKTRİK

Accessories / Aksesuarlar

Product Code Ürün Kodu	Product Name Ürün Adı	Units Per Box Kutudaki Adet	Units Per Package Kolidaki Adet
505-000111-800	Earthed Plug With Handle White / Red Topraklı Kulplu Fiş (08) - Beyaz / Kırmızı	50	300
505-000200-805	Deniz Golyad 3Gang Plugged Socket Outlet Deniz-Golyad Üçlü Topraklı Fiş Priz	-	24
505-000601-810	Plug Comply With Earthed Pin White / Red Monofaze Erkek Fiş - Beyaz / Kırmızı	50	300
505-000603-810	Plug Comply With Earth Pin White / Black Monofaze Erkek Fiş - Beyaz / Siyah	50	300
505-000701-811	Earthed Plug Comply With Earthed Pin White / Red Topraklı Erkek Fiş Ups'li - Beyaz / Kırmızı	50	300
505-000801-812	Earthed Plug Female Single Pin White / Red Monoblok Topraklı Dişi Fiş - Beyaz / Kırmızı	50	400
505-000803-812	Earthed Female Plug Single Pin White / Black Monoblok Topraklı Dişi Fiş - Beyaz / Siyah	50	400
505-001101-816	Earthed Plug White / Red Topraklı Erkek Fiş - Beyaz / Kırmızı	50	300
505-001103-816	Earthed Plug White / Black Topraklı Erkek Fiş - Beyaz / Siyah	50	300
505-001000-813	Delta Golyad 3Gang Plugged Socket Outlet Delta - Golyad Üçlü Topraklı Fiş Priz	-	48
505-001301-820	L Type Earthed Plug White / Red L Tipi Topraklı Fiş - Beyaz / Kırmızı	70	420
505-001500-305	Panel Mounted Socket (Grey) Pano Prizi (Gri)	-	150
505-002300-305	Panel Mounted Socket (Blue) Pano Prizi (Mavi)	-	150
505-000300-806	Intermediate Switch White/White Arapuar - Beyaz - Beyaz	50	300
505-000301-806	Intermediate Switch White/Red Arapuar - Beyaz - Kırmızı	50	300
505-000321-806	Intermediate Switch Black/Red Arapuar - Siyah - Kırmızı	50	300



Delta Golyad 3Gang Plugged Socket Outlet
Delta-Golyad 3'lü Topraklı Fiş Priz

505-001000-813



Deniz Golyad 3Gang Plugged Socket Outlet
Deniz 3'lü Golyad

505-000200-805



Earthed Plug With Handle White/Red
Topraklı Kulplu Fiş Beyaz / Kırmızı

505-000111-800



Earthed Plug White/Red
Topraklı Erkek Fiş Beyaz / Kırmızı

505-001101-816



L Type Earthed Plug W/R
L Tipi Topraklı Fiş Beyaz / Kırmızı

505-001301-820



Earthed Plug Comply With Earthed Pin White/Red
Topraklı Erkek Fiş UPS'li Beyaz / Kırmızı

505-000701-811



Plug Comply Without Earthed Pin White / Red
Monofaze Erkek Fiş Beyaz / Kırmızı

505-000601-810



Earthed Plug Female Single Pin White / Red
Monoblok Topraklı Dişi Fiş Beyaz / Kırmızı

505-000801-812



Intermediate Switch White / White
Arapuar Beyaz - Beyaz

505-000300-806



Intermediate Switch Black / Red
Arapuar Siyah - Kırmızı

505-000321-806



Intermediate Switch White / Red
Arapuar Beyaz - Kırmızı

505-000301-806



Panel Mounted Socket (Blue)
Pano Prizi (Mavi)

505-002300-305



Panel Mounted Socket (Grey)
Pano Prizi (Gri)

505-001500-305

Modular Case - Drywall (Without Cover)

Modüler Kasa - Alçıpan Duvar (Kapaksız)

Product Code Ürün Kodu	Product Name Ürün Adı	Units Per Box Kutudaki Adet	Units Per Package Koliadaki Adet
611-001703-832	3M Case For Under The Plaster Without Cover Standart (None Fire) 3M Alçıpan Kasa - Standart Alev Yaymayan	-	100
611-002613-832	3M Case For Under The Plaster Red Without Cover (None Fire & Halogen Free) 3M Alçıpan Kasa - Halogen Free, Alev Yaymayan (Kırmızı)	-	100
611-001704-832	4M Case For Under The Plaster Without Cover Standart (None Fire) 4M Alçıpan Kasa - Standart Alev Yaymayan	-	100
611-002614-832	4M Case For Under The Plaster Red Without Cover (None Fire & Halogen Free) 4M Alçıpan Kasa - Halogen Free, Alev Yaymayan (Kırmızı)	-	100
611-001707-832	7M Case For Under The Plaster Red Without Cover (None Fire) 7M Alçıpan Kasa - Standart Alev Yaymayan	-	100
611-002617-832	7M Case For Under The Plaster Without Cover Standart (None Fire & Halogen Free) 7M Alçıpan Kasa - Halogen Free, Alev Yaymayan (Kırmızı)	-	100

Modular Case - Under The Plaster (Without Cover)

Modüler Kasa - Sıvaaltı (Kapaksız)

Product Code Ürün Kodu	Product Name Ürün Adı	Units Per Box Kutudaki Adet	Units Per Package Koliadaki Adet
611-001703-928	3M Case For Under The Plaster Without Cover Standart (None Fire) 3M Sıvaaltı Kasa - Standart Alev Yaymayan	-	100
611-012653-928	3M Case For Under The Plaster Red Without Cover (None Fire & Halogen Free) 3M Sıvaaltı Kasa - Halogen Free, Alev Yaymayan (Kırmızı)	-	100
611-001704-928	4M Case For Under The Plaster Without Cover Standart (None Fire) 4M Sıvaaltı Kasa - Standart Alev Yaymayan	-	100
611-012654-928	4M Case For Under The Plaster Red Without Cover (None Fire & Halogen Free) 4M Sıvaaltı Kasa - Halogen Free, Alev Yaymayan (Kırmızı)	-	100
611-001707-928	7M Case For Under The Plaster Red Without Cover (None Fire) 7M Sıvaaltı Kasa - Standart Alev Yaymayan	-	100
611-012657-928	7M Case For Under The Plaster Red Without Cover (None Fire & Halogen Free) 7M Sıvaaltı Kasa - Halogen Free, Alev Yaymayan (Kırmızı)	-	100



Flush Mounted Box Orange Without Cover
Derin Boru Geçmeli Kasa Kapaksız-Turuncu

505-000030-828



Case For Brick Wall- Standad (Without Cover)

Tuğla Duvar Kasaları - Standart (Kapaksız)

Product Code Ürün Kodu	Product Name Ürün Adı	Units Per Box Kutudaki Adet	Units Per Package Koliadaki Adet
505-001700-829	Deep Flush Mounted Box Orange Without Cover (None Fire) Derin Boru Geçmeli Kasa - Alev Yaymayan	-	100
505-002610-829	Deep Flush Mounted Box Red Without Cover (None Fire & Halogen Free) Derin Boru Geçmeli Kasa - Kırmızı-Alev Yaymayan & Halojen Free	-	100
505-000000-833	Deep Flush Mounted Cover Yellow Derin Boru Geçmeli Kasa Kapak Sarı	-	100

Case For Under The Plaster- Standard (Without Cover)

Alçıpan Duvar Kasaları - Standart (Kapaksız)

Product Code Ürün Kodu	Product Name Ürün Adı	Units Per Box Kutudaki Adet	Units Per Package Koliadaki Adet
505-001700-832	Standart Flush Mounted Box Orange Without Cover (None Fire) Geçmeli Kasa - Alev Yaymayan	-	100
505-002610-832	Standart Flush Mounted Box Red Without Cover (None Fire & Halogen Free) Geçmeli Kasa - Kırmızı - Alev Yaymayan & Halojen Free	-	100

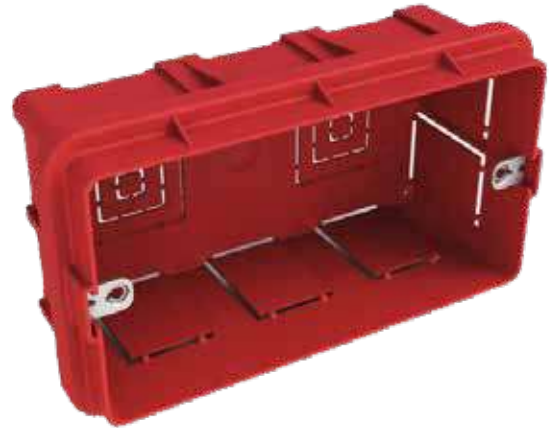



Notes / Notlar

turn on the life



Note:

ELBİ reserves the right to make technical changes or change the content of this document without prior notice.

Mutually agreed specifications will be valid for purchase orders.

ELBİ will not take any responsibility for possible errors or lack of information in this document.

Copyright of this document and the related subject and the images used here reserves.

Without the written consent of ELBİ, any kind of copying, use of third parties or benefiting from its contents - in whole or in part - is prohibited.

Our company is not responsible for typographic errors and color differences arising from the application of offset printing technique in product images.

Not:

ELBİ önceden haber vermeksizin teknik değişiklikler yapma veya bu dokümanın içeriğini değiştirme hakkını saklı tutmaktadır.

Satınalma siparişlerinde, üzerinde karşılıklı anlaşılmış özellikler geçerli olacaktır.

ELBİ, bu dokümandaki olası hatalar veya bilgi eksiklikleri için herhangi bir sorumluluk kabul etmeyecektir.

Bu doküman ve ilgili konu ile burada kullanılan resimlerin telif hakkını saklı tutmaktadır.

ELBİ'nin yazılı izni olmaksızın, her türlü kopyalama, üçüncü kişilerin kullanımı veya içeriğinden yararlanma - tümü ya da bir kısmı - yasaktır.

Tipografik hatalardan ve ürün görsellerinde ofset baskı tekniği uygulamasından kaynaklanan renk farklılaşmalarından firmamız sorumlu değildir.

© Copyright 2024 ELBİ Tüm hakları saklıdır.



RoHS



VDE

ELBİ Uluslararası Elektrik
Sanayi Tic. A.Ş.

Mehmet Akif Ersoy Mah.
Maltepe Cad.
No: 72 Taşoluk, Arnavutköy
İSTANBUL / TURKEY

Tel: +90 212 682 09 09

Export mail : destek@el-bi.com

Catalogs &
Certificates



#ELBİelektrik

#elbielektrik

#ELBİelektrik

elbielectric.com